

I-SIGN FLEX



www.cosign.be/isignflex

I-Sign Flex is an intelligent, modern sign system with a few unique characteristics:

1. The top of the acrylic cover plate is at the same level as the top of the aluminium frame with a visible rim of only 2.5 mm.
2. The I-Sign Flex comes with a spring system; this makes it very easy to remove the acrylic plate and replace the insert.
3. When mounting on a wall you can use double-sided tape or adjustable mount buttons.
4. The I-Sign Flex has a lock function to prevent vandalism.

I-Sign Flex est un système de signalisation intelligent et moderne avec quelques caractéristiques uniques:

1. Le dessus de la plaquette de couverture en acrylate se situe dans le même plan que le dessus du châssis en aluminium avec un petit bord visible d'à peine 2,5 mm.
2. L'I-Sign Flex est équipé d'un système à ressort qui facilite le retrait de la plaquette en acrylate afin de remplacer l'encart.
3. Pour un montage mural on peut utiliser aussi bien de la bande adhésive double face que des capuchons muraux adaptables.
4. Pour contrer les actes de vandalisme, l'I-Sign Flex est équipé d'une fonction de sécurité.

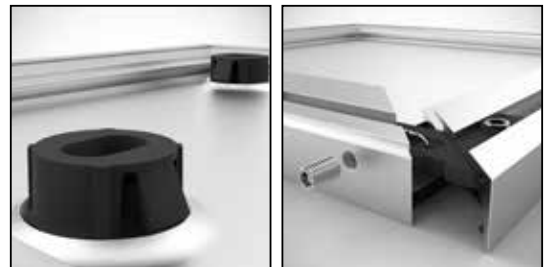
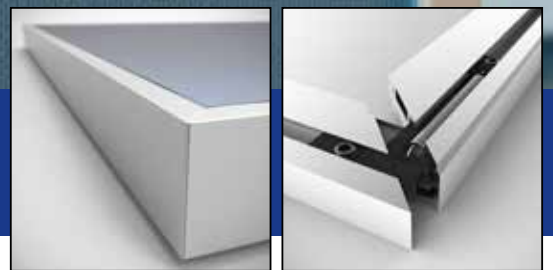

PROFILES & ACCESSORIES
COSIGN

CUSTOM MADE
COSIGN

READY MADE
COSIGN

STANDARD SIZES

DIMENSIONS STANDARD

WALL MOUNTED FIXATION MURALE



product code	insert (h x w) in mm / insert (h x l) en mm
I-052148-W	52 x 148,5
I-060210-W	60 x 210
I-105107-W	105 x 107
I-105148-W	105 x 148,5 (DIN A6)
I-105148-WS	105 x 148,5 (DIN A6 slider)
I-148150-W	148,5 x 150,5
I-210148-W	210 x 148,5 (DIN A5)
I-210212-W	210 x 212
I-210297-W	210 x 297 (DIN A4 landscape)
I-297210-W	297 x 210 (DIN A4 portrait)
I-297299-W	297 x 299
I-420297-W	420 x 297 (DIN A3 portrait)
I-594420-W	594 x 420 (DIN A2)
I-841594-W	841 x 594 (DIN A1)

SUSPENDED SYSTÈME DE SUSPENSION



product code	insert (h x w) in mm / insert (h x l) en mm
I-148297-S	148,5 x 297
I-148420-S	148,5 x 420
I-148600-S	148,5 x 600
I-148840-S	148,5 x 840
I-210297-S	210 x 297
I-210420-S	210 x 420
I-210600-S	210 x 600
I-210840-S	210 x 840

PROJECTED FIXATION EN DRAPEAU



product code	insert (h x w) in mm / insert (h x l) en mm
I-150148-P	150,5 x 148,5
I-212210-P	212 x 210
I-210297-P	210 x 297
I-297210-P	297 x 210

TABLE STAND PRÉSENTOIR DE TABLE



product code	insert (h x w) in mm / insert (h x l) en mm
I-052148-T	52 x 148,5

PROFILES & ACCESSORIES

PROFILÉS & ACCESSOIRES

PROJECTING PROFILE PROFILÉ À ANGLE DROIT



product code	description	
FLAG2000	anodised / anodisé	5m/l

PROJECTING BRACKET SUPPORT DE MONTAGE EN DRAPEAU



product code
I-BRACKET

SUCTION CUP VENTOUSE



product code
VACUUMC2



I-SIGN FIX



www.cosign.be/isignfix

The sleek design of the I-Sign range is extended to the I-Sign Fix; observe the elegant frame with invisible fixings.

Sheets of only 2 or 3 mm thick are mounted in the frame with a small, innovative clip. The sheets can be made from various materials: PVC, ACM, acrylic, aluminium, engraving materials, etc. This results in a high degree of personalisation.

Le design élégant de la gamme I-Sign, sans fixation apparente, se retrouve également chez l'I-Sign Fix.

A l'aide d'un petit clip innovant les plaquettes d'une épaisseur de 2 ou 3 mm sont fixées sur le châssis. Différents matériaux peuvent être utilisés pour les plaques : PVC, ACM, acrylate, aluminium, matériaux à graver, etc., permettant un degré élevé de personnalisation.



PROFILES & ACCESSORIES
COSIGN

CUSTOM MADE
COSIGN

READY MADE
COSIGN

STANDARD SIZES

DIMENSIONS STANDARD

WALL MOUNTED FIXATION MURALE



product code insert (hwx) in mm / insert (lxh) en mm

IF-150150-W	150 x 150
IF-150300-W	150 x 300
IF-150600-W	150 x 600
IF-297210-W	297 x 210 (DIN A4)
IF-297420-W	297 x 420 (DIN A3)

product code insert (hwx) in mm / insert (lxh) en mm

IF-150150-W-B	150 x 150 - Black
IF-150300-W-B	150 x 300 - Black
IF-150600-W-B	150 x 600 - Black
IF-297210-W-B	297 x 210 (DIN A4) - Black
IF-297420-W-B	297 x 420 (DIN A3) - Black

SUSPENDED SYSTÈME DE SUSPENSION



product code insert (hwx) in mm / insert (lxh) en mm

IF-150150-S	150 x 150
IF-150300-S	150 x 300
IF-150600-S	150 x 600

product code insert (hwx) in mm / insert (lxh) en mm

IF-150150-S-B	150 x 150 - Black
IF-150300-S-B	150 x 300 - Black
IF-150600-S-B	150 x 600 - Black

PROJECTED FIXATION EN DRAPEAU



product code insert (hwx) in mm / insert (lxh) en mm

IF-150150-P	150 x 150
IF-150300-P	150 x 300

product code insert (hwx) in mm / insert (lxh) en mm

IF-150150-P	150 x 150 - Black
IF-150300-P	150 x 300 - Black

I-FLAG 150 x 161

SUCTION CUP / VENTOUSE



product code

VACUUMC2

PROFILES & ACCESSORIES

PROFILÉS & ACCESSOIRES

ALUMINIUM PROFILES PROFILÉS ALUMINIUM



product code	description	
IF-WM1000	mill finish / brut	5m/l
IF-WM2000	anodised / anodisé	5m/l
IF-WM5000	black anodised / anodisé noir	5m/l



product code	description	
IF-SP1000	mill finish / brut	5m/l
IF-SP2000	anodised / anodisé	5m/l
IF-SP5000	black anodised / anodisé noir	5m/l



product code	description	
FLAG2000	projected / perpendiculaire anodised / anodisé	5m/l

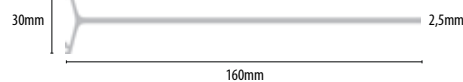

PROJECTING BRACKET SUPPORT DE MONTAGE EN DRAPEAU



product code

I-BRACKET

CORNER SECTION / PIÈCE D'ANGLE



product code

IF-CORNER

MOUNTING CLIP / CLIP DE FIXATION



product code

I-CLIP

CONNECTOR / CONNECTEUR



product code

I-CONNECTOR

HANGING CLIP / CLIP DE SUSPENSION



product code

APC-3000S

HANGING KIT / KIT DE SUSPENSION



product code	description
APC4101	2x conical clip + 1,5m wire 2x clip conique + 1,5m fil

See also page 54 for more suspension systems.
Pour plus d'infos sur les systèmes de suspension,
voyez également sur la page 54.

I-SIGN ECO

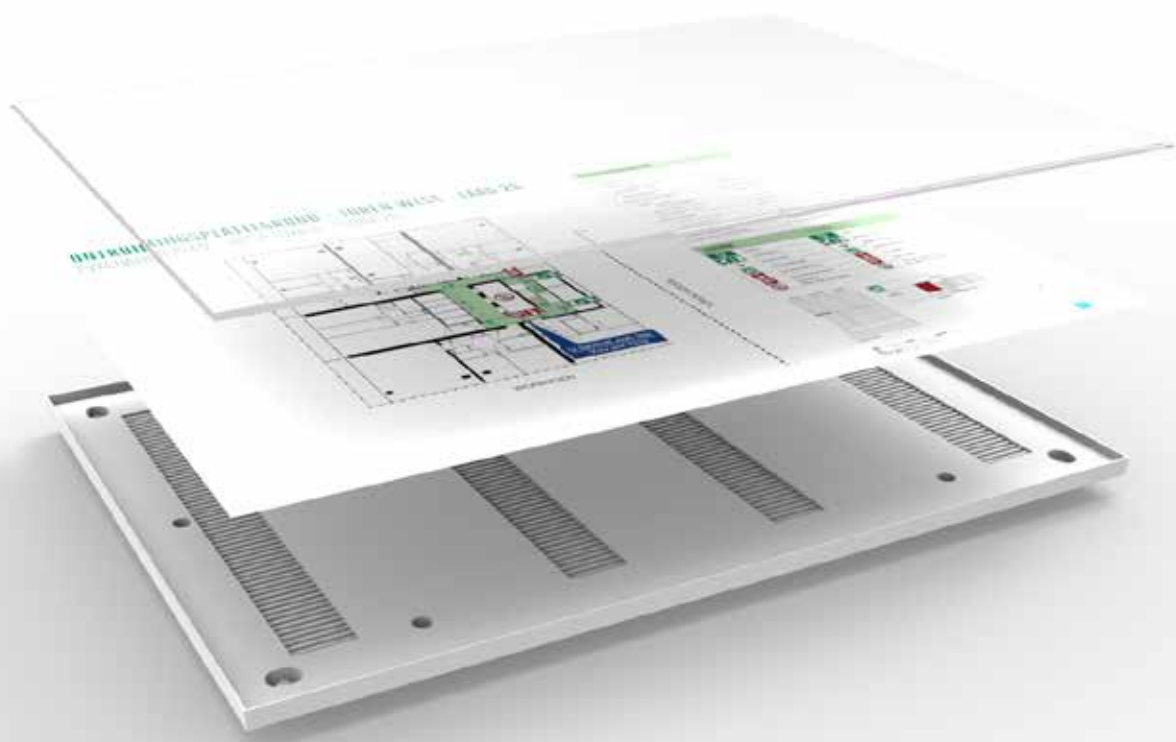

www.cosign.be/i-sign-eco

I-Sign Eco is the newest member of the I-Sign family. I-Sign Eco maintains the same sleek design with the thin edge which became so typical for the entire I-Sign range.

It is possible to create single-sided wall mounting or double-sided suspended or flag mounting signs.

I-Sign Eco est le produit le plus récent de notre gamme I-Sign. I-Sign Eco conserve le même design moderne avec une fine bordure, typiquement pour toute la gamme I-Sign.

Il est possible de créer des enseignes de montage mural (simple face), suspendues au plafond (double face) ou fixation en drapeau (double face).



CUSTOM
MADE

READY
MADE

One Frame, Two Functions

Un Cadre, Deux Fonctions

The user can choose between a flexible version with a paper inlay behind a non-reflecting acrylic cover, or a more fixed version with 2 or 3mm thick sheets in different materials like PVC, ACM, acrylic or aluminium which allow for a highly customized solution.

L'utilisateur peut choisir entre une version flexible avec une feuille de papier derrière une face acrylique non réfléchissante, et une version plus fixe avec des plaques de 2 ou 3 mm d'épaisseur dans différents matériaux comme le PVC, l'ACM, l'acrylique ou l'aluminium, ce qui permet une solution hautement personnalisée.

I-SIGN ECO FIX

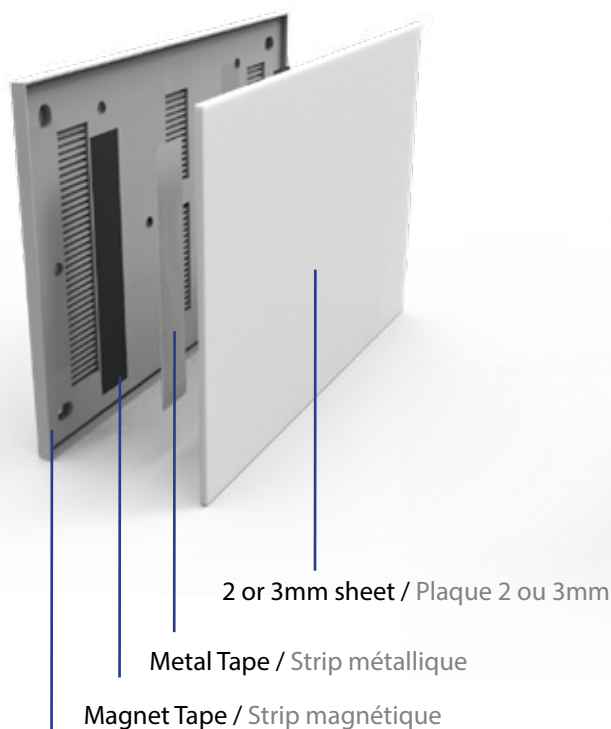

I-Sign Eco frame / Cadre I-Sign Eco

I-SIGN ECO FLEX

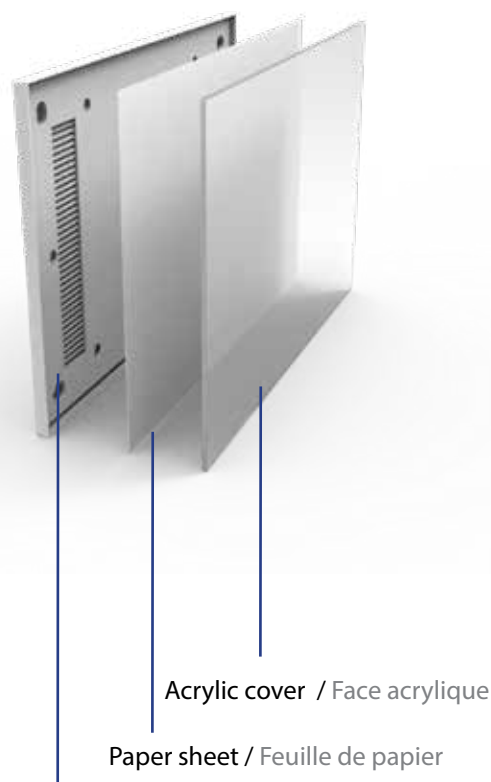

I-Sign Eco frame / Cadre I-Sign Eco

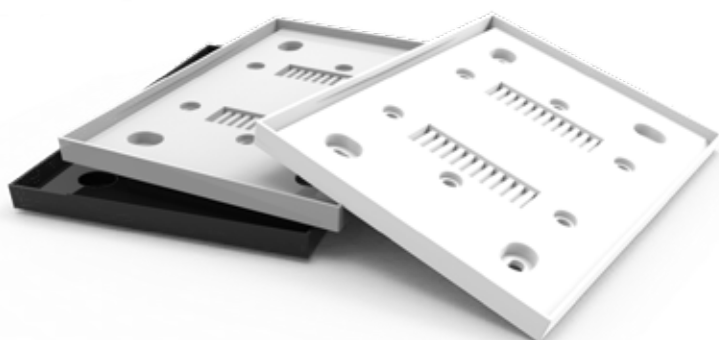

The frames, which are available in sizes DIN A6, DIN A5, DIN A4, DIN A3, 150x150mm and 150x300mm, are injection molded in abs plastic and are available in different colors.

Standard colors are aluminium grey and black.

Les cadres, disponibles en DIN A6, DIN A5, DIN A4, DIN A3, 150x150mm et 150x300mm, sont moulés en plastique ABS (processus d'injection) et disponibles en différentes couleurs.

Les couleurs standard sont gris aluminium et noir.

I-SIGN ECO FLEX

WALL MOUNTED / FIXATION MURALE

I-Sign Eco Flex Wall Mounted. Included: I-Sign Eco Frame, Acrylic cover.

I-Sign Eco Fixation Murale. Inclus: Cadre I-Sign Eco, Face acrylique.

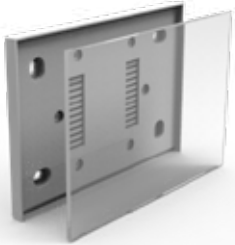

product code	insert (hwx) in mm
IE-150150-W-X	150 x 150
IE-150300-W-X	150 x 300
IE-105148-W-X	105 x 148,5 (DIN A6)
IE-210148-W-X	210 x 148,5 (DIN A5)
IE-210297-W-X	210 x 297 (DIN A4)
IE-420297-W-X	420 x 297 (DIN A3)

X = colour code:

W: White, B: Black, G: Grey
(Other colours available on request.)

X = Code de couleur:

W: Blanc, B: Noir, G: Gris
(Autres couleurs disponibles sur demande.)

PROJECTED / FIXATION EN DRAPEAU

I-Sign Eco Flex Projected. Fully assembled including: 2x I-Sign Eco Frames, Connection Pins, Interior Cover, Flag system, Acrylic covers.

I-Sign Eco Fixation en Drapeau. Entièrement assemblé inclus: 2x Cadre I-Sign Eco, Connexions, Couverture l'intérieur, Système en drapeau, Faces acryliques.



product code	insert (hwx) in mm
IE-150150-P-X	150 x 150
IE-150300-P-X	150 x 300
IE-210297-P-X	210 x 297 (DIN A4 landscape)
IE-297210-P-X	297 x 210 (DIN A4 portrait)

X = colour code:

W: White, B: Black, G: Grey
(Other colours available on request.)

X = Code de couleur:

W: Blanc, B: Noir, G: Gris
(Autres couleurs disponibles sur demande.)

SUSPENDED / SYSTÈME DE SUSPENSION

I-Sign Eco Flex Suspended. Included: 2x I-Sign Eco Frames, Connection Pins, Interior Cover, Suspension cables, Acrylic covers.

I-Sign Eco Flex Systeme de suspension. Entièrement assemblé inclus: 2x Cadres I-Sign Eco, Connexions, Couverture l'intérieur, Fils de suspension, Faces acryliques.

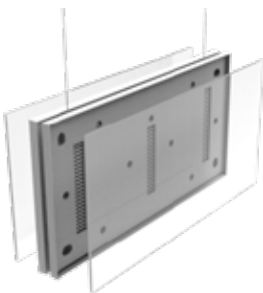

product code	insert (hwx) in mm
IE-150150-S-X	150 x 150
IE-150300-S-X	150 x 300
IE-210297-S-X	210 x 297 (DIN A4 landscape)
IE-297210-S-X	297 x 210 (DIN A4 portrait)

X = colour code:

W: White, B: Black, G: Grey
(Other colours available on request.)

X = Code de couleur:

W: Blanc, B: Noir, G: Gris
(Autres couleurs disponibles sur demande.)

See also page 52 in our architectural brochure for more suspension systems.

Voir également page 52 dans notre brochure architectural pour plus d'infos sur nos systèmes de suspension.

ACCESSORIES / ACCESSOIRES



product code	description
IE-CONNECTOR	Connector to combine two I-Sign Eco frames. Connexion pour connecter deux cadre I-Sign Eco.



APC-3000-S	Suspension Clip. Clip de suspension.
------------	---



APC-CABLE-1.5	1.5mm thick galvanized cable (7x7). 1,5m length with 4,5mm ball nipple.
---------------	--

1.5mm fil galvanisé (7x7) 1,5m de longueur avec un téton sphérique de 4,5mm de diamètre.



I-FLAG3-100	I-Flag 3 profile with mount 100mm I-Flag 3 profilé avec support 100mm
-------------	--

I-FLAG3-150	I-Flag 3 profile with mount 150mm I-Flag 3 profilé avec support 150mm
-------------	--

I-SIGN ECO FIX

WALL MOUNTED / FIXATION MURALE

I-Sign Eco Flex Wall Mounted. Included: I-Sign Eco Frame.

I-Sign Eco Fixation Mural. Inclus: I-Sign Eco Cadre.



product code	insert (hwx) in mm
IFE-150150-W-X	150 x 150
IFE-150300-W-X	150 x 300
IFE-105148-W-X	105 x 148,5 (DIN A6)
IFE-210148-W-X	210 x 148,5 (DIN A5)
IFE-210297-W-X	210 x 297 (DIN A4)
IFE-420297-W-X	420 x 297 (DIN A3)

X = colour code:

W: White, B: Black, G: Grey
(Other colours available on request.)

X = Code de couleur:

W: Blanc, B: Noir, G: Gris
(Autres couleurs disponibles sur demande.)

PROJECTED / FIXATION EN DRAPEAU

I-Sign Eco Flex Projected. Fully assembled including: 2x I-Sign Eco Frames, Connection Pins, Interior Cover, Flag system.

I-Sign Eco Fixation en Drapeau. Entièrement assemblé inclus: 2x I-Sign Eco Cadre, , Couverture l'intérieur, Système en drapeau.

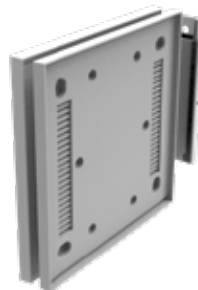

product code	insert (hwx) in mm
IFE-150150-P-X	150 x 150
IFE-150300-P-X	150 x 300
IFE-210297-P-X	210 x 297 (DIN A4 landscape)
IFE-297210-P-X	297 x 210 (DIN A4 portrait)

X = colour code:





W: White, B: Black, G: Grey
(Other colours available on request.)

X = Code de couleur:

W: Blanc, B: Noir, G: Gris
(Autres couleurs disponibles sur demande.)

ACCESSORIES / ACCESSOIRES

product code description

	IE-COV150150 Cover to hide I-Sign Eco frame interior. For 150x150mm projected. Couverture pour cacher l'intérieur de l'assemblage Pour 150x150mm fixation en drapeau
	IE-COV150300 Cover to hide I-Sign Eco frame interior. For 150x300mm suspended. Couverture pour cacher l'intérieur de l'assemblage Pour 150x300mm système de suspension
	IE-COV300150 Cover to hide I-Sign Eco frame interior. For 150x300mm projected. Couverture pour cacher l'intérieur de l'assemblage Pour 300x150mm fixation en drapeau
	IE-COV210297 Cover to hide I-Sign Eco frame interior. For 210x297mm suspended. Couverture pour cacher l'intérieur de l'assemblage Pour 150x150mm système de suspension
	IE-COV297210 Cover to hide I-Sign Eco frame interior. For 210x297mm projected. Couverture pour cacher l'intérieur de l'assemblage Pour 150x150mm fixation en drapeau

SUSPENDED / SYSTÈME DE SUSPENSION

I-Sign Eco Flex Suspended. Included: 2x I-Sign Eco Frames, Connection Pins, Interior Cover, Suspension cables.

I-Sign Eco Flex Systeme de suspension. Entièrement assemblé inclus: 2x Cadres I-Sign Eco, Couverture l'intérieur, Connexions, Fils de suspension.

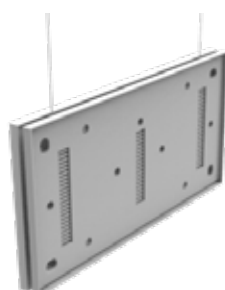

product code	insert (hwx) in mm
IFE-150150-S-X	150 x 150
IFE-150300-S-X	150 x 300
IFE-210297-S-X	210 x 297 (DIN A4 landscape)
IFE-297210-S-X	297 x 210 (DIN A4 portrait)

X = colour code:

W: White, B: Black, G: Grey
(Other colours available on request.)

X = Code de couleur:

W: Blanc, B: Noir, G: Gris
(Autres couleurs disponibles sur demande.)

See also page 52 in our architectural brochure for more suspension systems.

Voir également page 52 dans notre brochure architectural pour plus d'infos sur nos systèmes de suspension.

I-FLAG



www.cosign.be/iflag

Cosign developed a universal FLAG profile which can be used as a stand-alone product, to be mounted directly to the wall or ceiling, or in combination with other Cosign products like the I-Sign Eco, I-Sign Flex or I-Sign Fix frames.

First an aluminium mounting profile is fixed to the wall or ceiling, then the flag profile with or without frames mounted on it is slid over the mounting profile and fixed with a set screw.

Cosign a développé un profil, qui s'appelle I-FLAG2 et qui peut être utilisé comme produit autonome - pour être monté directement sur le mur ou le plafond - ou en combinaison avec d'autres produits Cosign comme les cadres I-Sign Eco, I-Sign Flex ou I-Sign Fix.

Tout d'abord, un profil de montage en aluminium est fixé au mur ou au plafond, puis le profil de drapeau - avec ou sans cadres montés dessus - est glissé sur ce profilé de montage et fixé avec une vis de réglage.

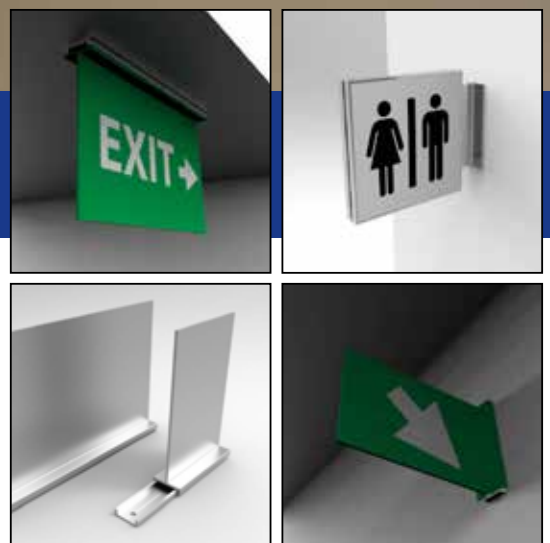

PROFILES & ACCESSORIES

CUSTOM MADE

READY MADE

STANDARD SIZES

DIMENSIONS STANDARD

I-FLAG 1

Standalone or in combination with I-Sign Fix/Flex
Autonome ou en combinaison avec I-Sign Fix/Flex



product code

I-FLAG1

I-Flag 1 with mount 150mm
I-Flag 1 profilé avec support 150mm

I-FLAG 2

Standalone
Autonome



product code

I-FLAG2-150

I-Flag 2 with mount 150mm
I-Flag 2 profilé avec support 150mm

I-FLAG2-300

I-Flag 2 with mount 300mm
I-Flag 2 profilé avec support 300mm

PROFILES & ACCESSORIES

PROFILÉS & ACCESSOIRES

FLAG1-2000



product code

FLAG1-2000

anodised / anodisé

5m/l

PROJECTING BRACKET SUPPORT DE MONTAGE EN DRAPEAU



product code

I-BRACKET

Bracket for Flag1-2000
Support pour Flag1-2000

FLAG2-2000



product code

FLAG2-2000

anodised / anodisé

5m/l

MOUNT2-1000



product code

MOUNT2-1000

mill finish / brut

5m/l



I-SIGN DISPLAY



www.cosign.be/isigndisplay

The single-sided I-Sign Display profiles make it possible to frame large panels, digital prints and art virtually without an edge and without visible fixings. This makes them very suitable for use in museums, galleries and interior decoration.

The double-sided profile is extremely suitable for making thin light boxes and illuminated or non-illuminated indoor pillars.

Double-sided tape, magnetic tape or the 3M Dual Lock™ reclosable fastener can be used to affix the panels.

PROFILES &
ACCESSORIES

CUSTOM
MADE



Les profils I-Sign Display à simple face permettent d'encadrer pratiquement sans bords les grands panneaux, les impressions numériques et les affiches artistiques, ce qui les rend appropriés pour des applications dans les musées, les galeries et pour les décorations d'intérieur.

Le profil à double face convient tout particulièrement pour la réalisation de caissons lumineux minces et de petites colonnes d'intérieur, avec ou sans éclairage.

Pour la fixation des panneaux il est possible d'utiliser aussi bien des bandes magnétiques que du Velcro ou le Dual Lock™ refermable de 3M ou bien des bandes adhésives double face.

SINGLE-SIDED

SIMPLE FACE

ALUMINIUM PROFILE / PROFILÉ ALUMINIUM

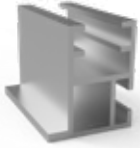

product code	description	
ID-SS1000	mill finish / brut	5m/l
ID-SS2000	anodised / anodisé	5m/l
ID-SS5000	black anodised / anodisé noir	5m/l

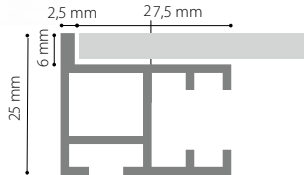

CORNER CONNECTOR / RACCORD D'ANGLE



product code
ID-SS CORNER

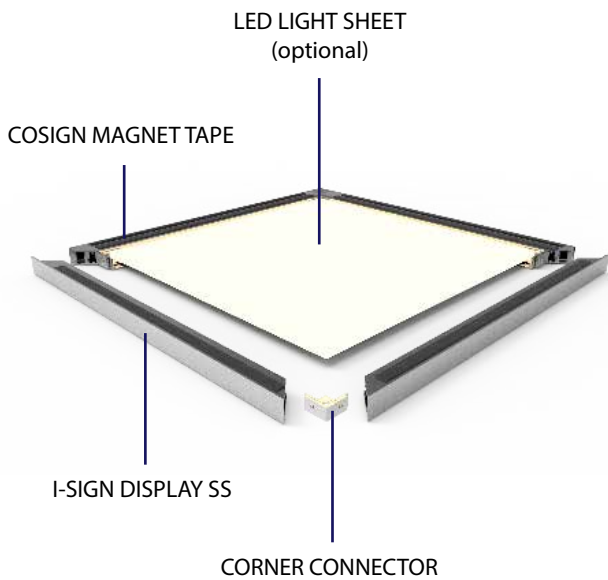

DOUBLE-SIDED SLIM

DOUBLE FACE SLIM

ALUMINIUM PROFILE / PROFILÉ ALUMINIUM

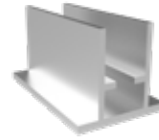

product code	description	
ID-SLIM1000	mill finish / brut	5m/l
ID-SLIM2000	anodised / anodisé	5m/l

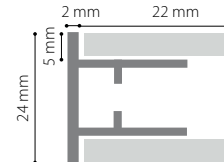

CORNER CONNECTOR / RACCORD D'ANGLE



product code
ID-SL CORNER

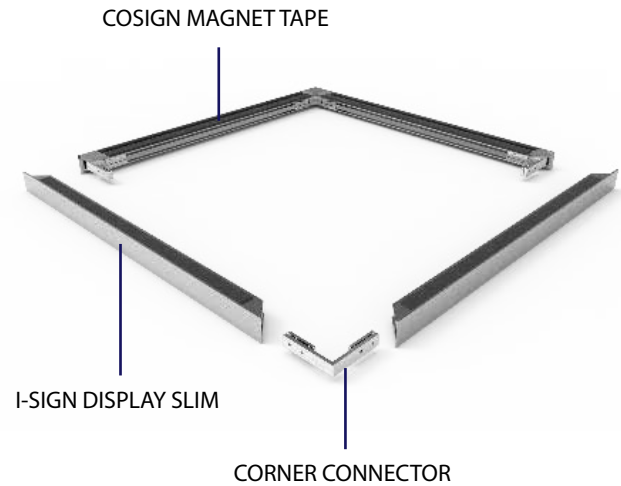

MAGNETIC STRIPS / STRIPS MAGNÉTIQUES



product code	description	
MAG12.7/1.5A5	isotropic A, 5 poles	12,7 x 1,5 mm
MAG12.7/1.5B5	isotropic B, 5 poles	12,7 x 1,5 mm
MAG25.4/1.5A9	isotropic A, 9 poles	25,4 x 1,5 mm
MAG25.4/1.5B9	isotropic B, 9 poles	25,4 x 1,5 mm
MAG12.7/1.0A5	anisotropic A, 5 poles	12,7 x 1 mm
METAL13	metal strip	13 x 0,22 mm
METAL25	metal strip	25 x 0,22 mm

DOUBLE-SIDED

DOUBLE FACE

ALUMINIUM PROFILE / PROFILÉ ALUMINIUM



product code	description	
ID-DS1000	mill finish / brut	5m/l
ID-DS2000	anodised / anodisé	5m/l
ID-DS5000	black anodised / anodisé noir	5m/l

CORNER CONNECTOR / RACCORD D'ANGLE



product code
ID-DS CORNER

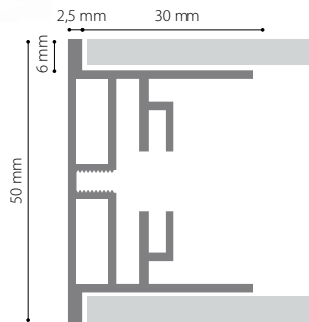

COSIGN MAGNET TAPE

LUCOLED EL31

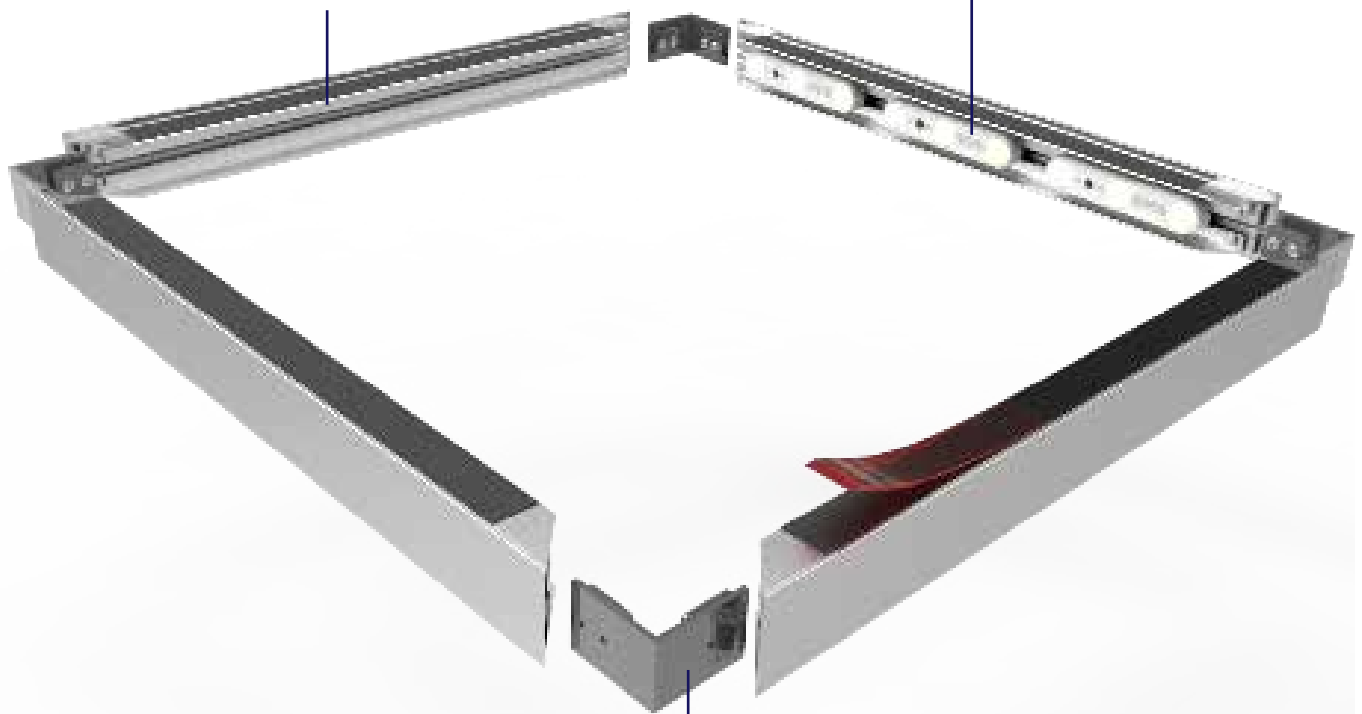

CORNER CONNECTOR



LUCOLED EL31



product code	description
EL31-W65	12 VDC 327lm / module 2,88W / module

POWER SUPPLY / SOURCE D'ALIMENTATION



product code	description
PPS1230	Lucoled Slim 12 VDC / 30W
PPS1260	Lucoled Slim 12 VDC / 60W
PPS12100	Lucoled Slim 12 VDC / 100W
PP12150	Lucoled 12 VDC / 150W
PP12200	Lucoled 12 VDC / 200W