

Lucoline®

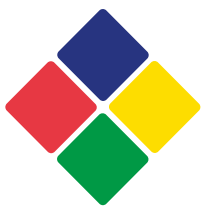

LUCOLED

Experience Lighting

Lucoline®

INTRODUCTION 03

FEATURES 04

TECHNICAL SPECIFICATIONS 05

ACCESSORIES 06

CORNERS AND JOINT COVER 07

POWER SUPPLIES 08

ELECTRIC LAYOUT EXAMPLE 08

INSTALLATION 09

CUTTING 11





INTRODUCTION

Based on over 20 years of experience selling and installing linear tubing products globally Lucoled has completely redesigned the new Lucoline® range.

Lucoline® is designed to be used in architectural linear accent lighting applications such as petrol station canopies, building outlines, interior accents etc..

Lucoline® uses advanced optics to create an even, bright, illumination in a 30 mm extruded profile. It has a condensation proof design with an integrated breather filter and silicon coated aluminium PCB's in an aluminium carrier profile.

Lucoline® is designed to be installed quickly and easily on any building structure surface. It has a plug-and play IP67 JST connector system. Lucoline® is cuttable every 55 mm and is easily resealable. The remaining cut piece can be used elsewhere in the installation, thus minimizing waste and optimizing material use.

Lucoline® is available in a large range in standard colours but also in full RGB and dot controllable RGB to create spectacular effects. Custom colours are also possible.



FEATURES



Advanced optics

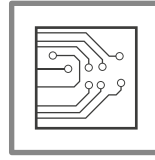

Advanced electronics



IP67 condensation proof



Short term ROI, value proposition



UV stable



Standard colours and RGB

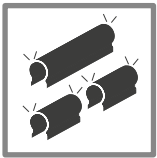

Cut Section can be reused

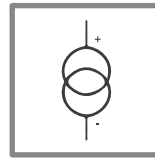

Constant current & current limiting technology

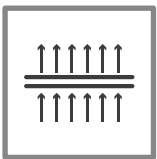

Breather filter









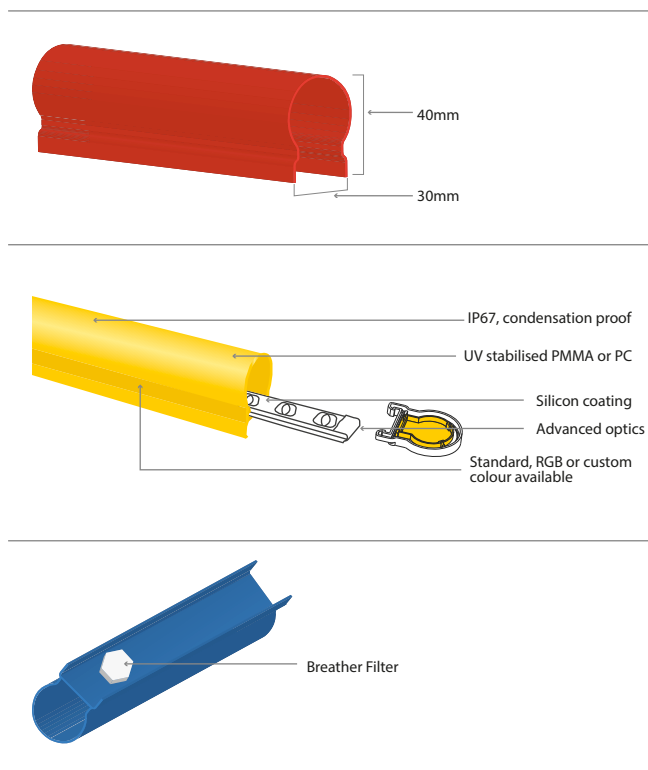





Quick and Easy Install

TECHNICAL SPECIFICATIONS

Dimensions	30mm (W) x 45mm (H)
Lengths	2370mm, 1186mm, 600mm
Cuttable	Cuttable every 55mm. RGB 145 mm
Housing material	extruded UV stable PMMA (UL94-HB) or PC (UL94-V0)
Input voltage	24V DC
Protection class	IP67
Connector system	JST JWPF IP67 connectors
Mounting clip	UV stabilized polycarbonate
Mounting clip pull force	>17kgs
Mounting clip shear force	>30kgs
Long lifespan	> 80.000 hours
Operating temperature	-30°C - +60°C
Warranty	5 years extended warranty
Certification	CE, ROHS



LUCOLINE TUBES

	Description	Colour	Brightness	Power
	PMS 285C Blue		450cd/m ²	5.0W/m
L-LG-x	PMS 7488C Light Green		800cd/m ²	5.0W/m
L-G-x	PMS 348 Dark Green		270cd/m ²	5.0W/m
L-LY-x	PMS 116C Lemon Yellow		1350cd/m ²	5.0W/m
L-Y-x	PMS 2010C Yellow		1500cd/m ²	5.0W/m
L-O-x	PMS 172C Orange		670cd/m ²	5.0W/m
L-RR-x	PMS 1797C Red, red LED		400cd/m ²	5.0W/m
L-R-x	PMS 1797C Red, white LED		320cd/m ²	5.0W/m
L-W-x	RAL 9016 White, 6500K		2000cd/m ²	5.0W/m
L-WW-x	RAL 9016 White, 3000K		1400cd/m ²	5.0W/m
L-P-x	PMS 235 Purple		500cd/m ²	5.0W/m
L-RGB-x	RGB		R= 300cd/m ² G= 780cd/m ² B= 1800cd/m ²	5.8W/m
L-RGBDC-x	RGB Dot Controlled		W= 1240cd/m ²	

Note: "x" indicates length (2370mm, 1186mm, 600mm)

ACCESSORIES

ITEM NO.	DESCRIPTION
L-CLIP-S	Mounting clip sliding
L-CLIP-F	Mounting clip fixed
L-c-JNT	Joint cover
L-c-CRN-STP	Step corner
L-c-CRN-OUT	Outside corner
L-c-CRN-INS	Inside corner
L-c-END	End cap
L-CAB-Y-1.5	Power supply Y connection cable 1.5m, 1 male & 1 female connector
L-CON-Y	Y-Connector, 1 male and 2 female connectors
L-CAB-1.0	Extension cable 1.0 m Male/Female JST connector
L-CAB-3.0	Extension cable 3.0 m Male/Female JST connector
L-CON-BNK-M	Blanking connector male
L-CON-BNK-F	Blanking connector female
L-CON-BNK-RGB-M	Blanking connector RGB male
L-CON-BNK-RGB-F	Blanking connector RGB female

Note: c indicates colour (B, LG, G, LY, Y, O, RR, R, W, RGB, RGBDC)

Step corner

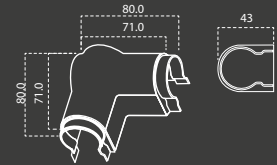

Inner corner

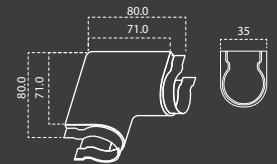

Joint corner

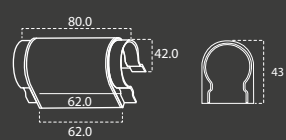

Outside corner

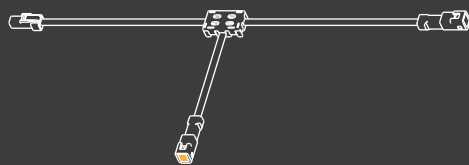
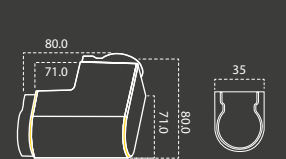

Y-Connector (L-CON-Y)

Sliding clip



Fixed clip

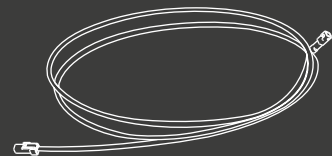
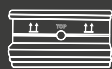

Connection cable 1.0m (L-CAB-1.0)



Power supply Y connection cable 1.5m (L-CAB-Y-1.5)

End cap

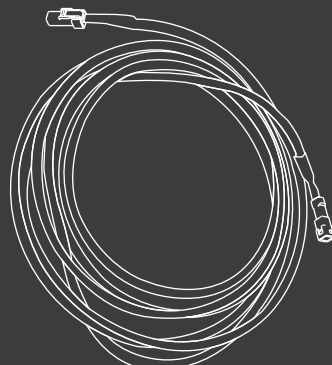

Connection cable 3.0m (L-CAB-3.0)

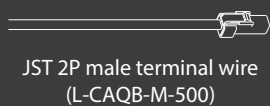

JST 2P male terminal wire (L-CAQB-M-500)



JST Blanking connector male (L-CON-BNK-F)



JST Blanking connector RGB female (L-CON-BNK-RGB-F)



JST 4P male terminal wire (L-CAB-RGB-M)



JST 2P female terminal wire (L-CAB-F-500)



JST Blanking connector female (L-CON-BNK-M)



JST Blanking connector RGB male (L-CON-BNK-RGB-M)



JST 4P female terminal wire (L-CAB-RGB-F)

CORNERS AND JOINT COVER OPTIONS

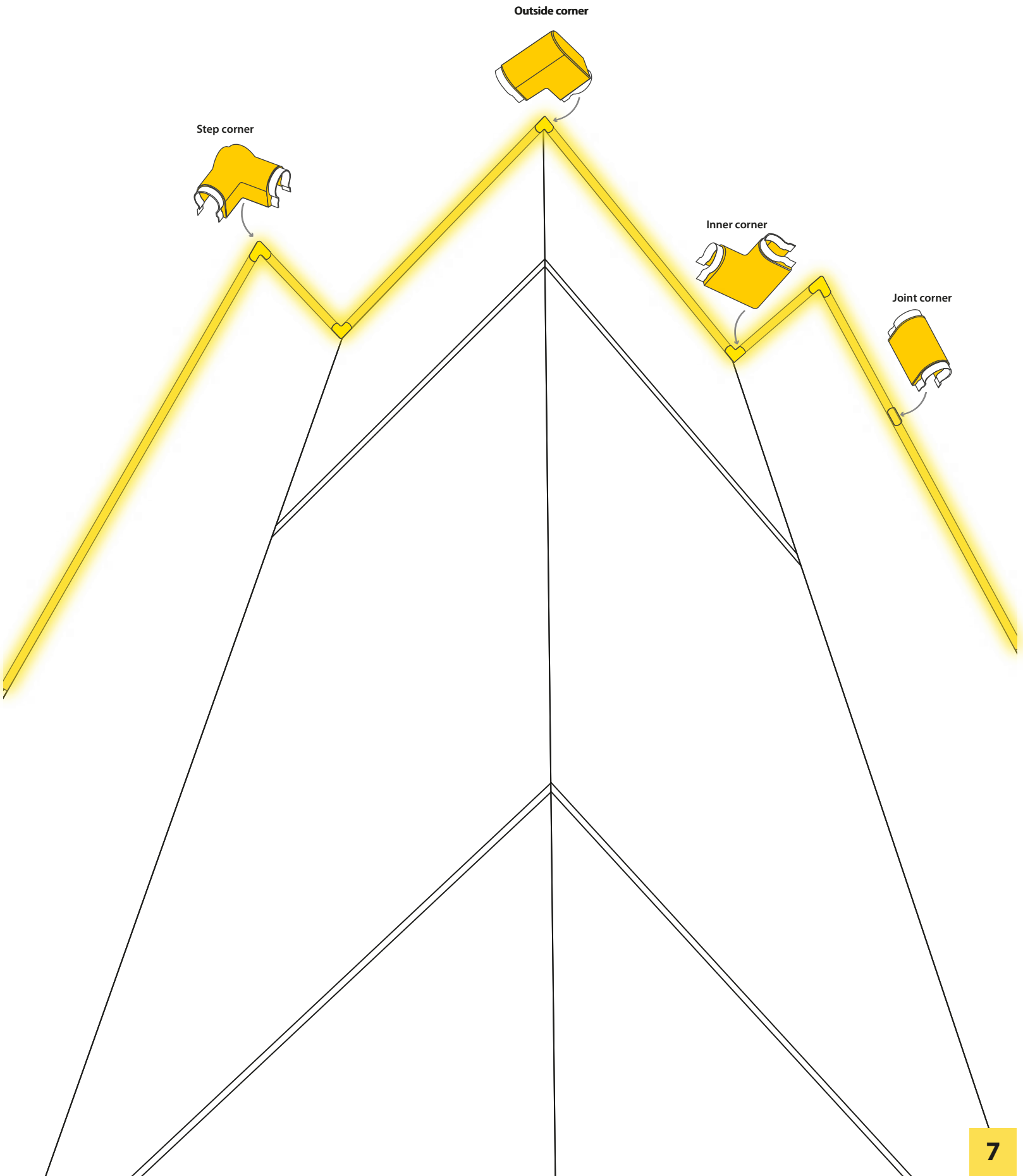

POWER SUPPLIES

Specification 24V Power Supply

Code	Output Current	Output Power	Input Current	Efficiency	Size	Weight
PP2460	2.5A	60W	0.65A/115V-0.35A/230V	≥ 87%	184x44x34mm	0.52kg
PP24100	4.16A	100W	1.1A/115V-0.55A/230V	≥ 92%	204x67x35mm	0.88kg
PP24150	6.25A	150W	1.6A/115V-0.8A/230V	≥ 93%	234x68x35mm	1kg
PP24200	8.34A	200W	2.8A max	≥ 90%	295x60x36mm	1.1kg

Power Supply Capacity

Item	PP2460	PP24100	PP24150	PP24200
Power Output	60W	100W	150W	200W
All Lucoline® colours(5.0W/m)	11m	18m	27m	38m
RGB & RGB dot control	9m	15m	23m	31m

Maximum 4 sections of 2370mm | 9.6 m length in series

ELECTRIC LAYOUT EXAMPLE

Installation Index

1. Standard Lucoline® tubes (2370mm, 1186mm, 600mm)
2. On-site adjusted length
3. Power Supply (PP2460, PP24100, PP24150, PP24200)
4. 3M Scotchlok™ 314
5. Power Supply Y Connection Cable 1.5m
6. Y connector
7. Connection cable (1.0m, 3.0m)
8. Blanking connectors

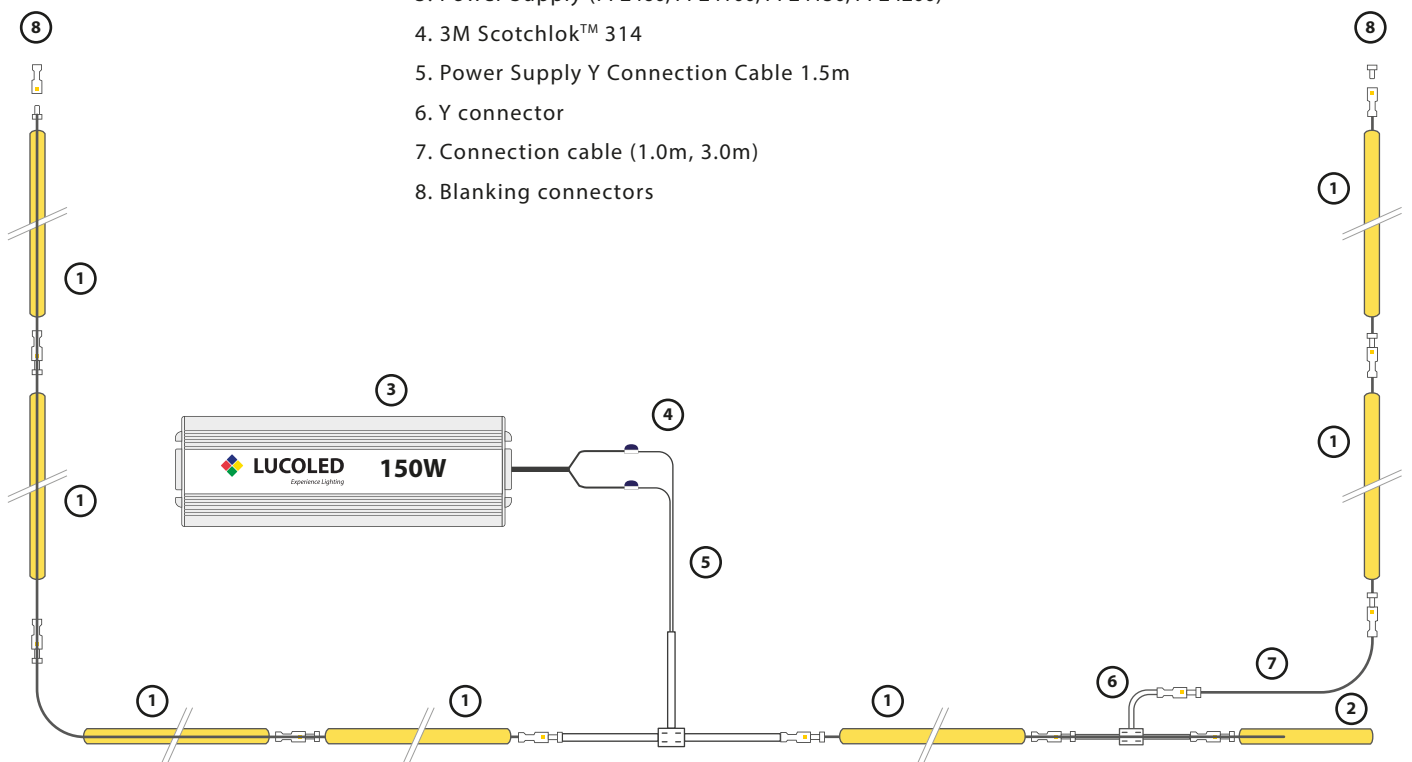

INSTALLATION

1. Layout:

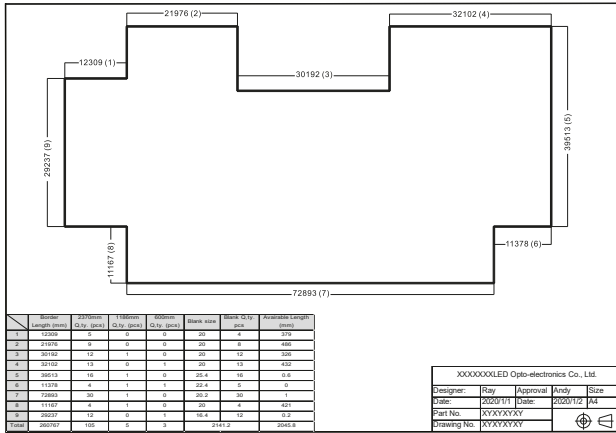

Use a building layout drawing with all lengths of the sides where Lucoline® should be installed to calculate the number of standard lengths, corners, cables and power supplies needed.

2. Prepare installation:

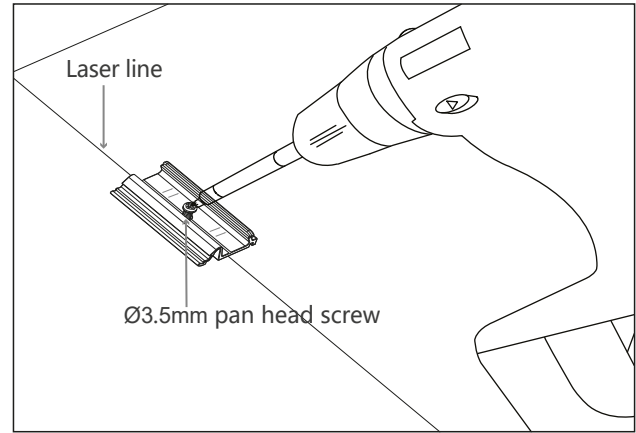

Use a laser line to mark the horizontal line on the building where the mounting clips should be installed. Per section install one Fixed Clip (L-CLIP-F) in the middle of the section to prevent it from moving on the building under temperature influences. Use Sliding Clips (L-CLIP-S) at a maximum repeat distance of 400 mm apart.

3. Types of mounting clips:

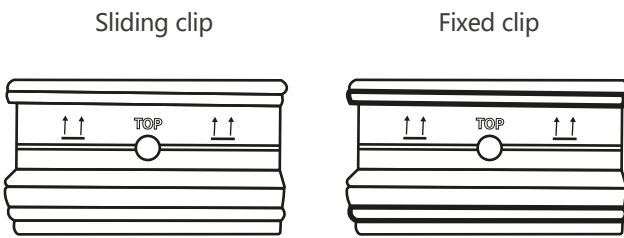

The Fixed Clip (L-CLIP-F) has rubber bands to prevent the tube from sliding. Only one should be used per section on a horizontal installation. In the case of a vertical installation use a Fixed Clip for every other clip to prevent the tube from sliding down under its own weight.

4. Install Lucoline® on clips:

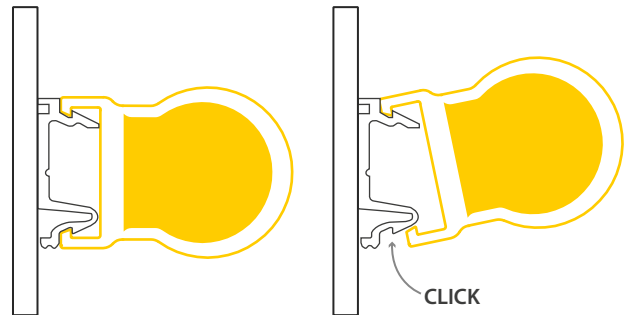

Hang the tube in the top side of all clips. Push the tube downward to snap it into the spring part of each clip. Check that the tube is secured in all clips, especially the Fixed Clip.

5. Installation tube on clips:

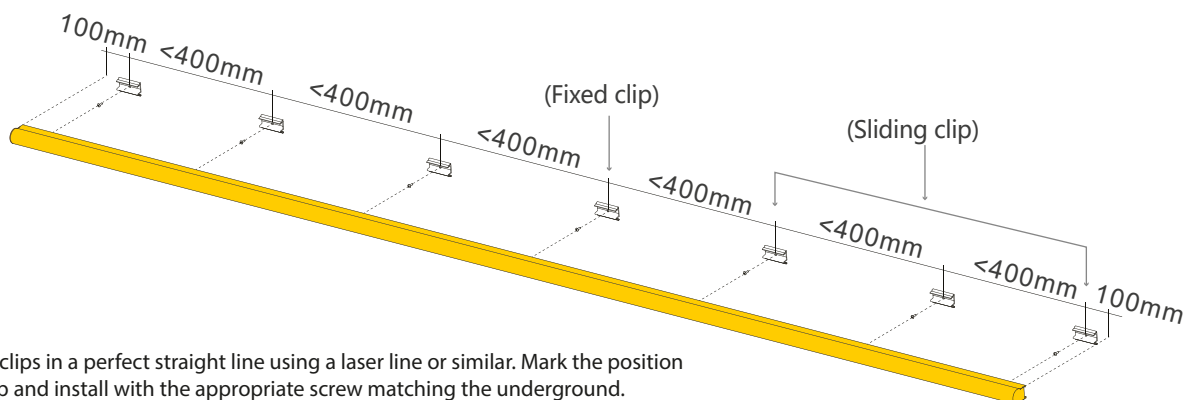

Install the clips in a perfect straight line using a laser line or similar. Mark the position of each clip and install with the appropriate screw matching the underground. Install one Fixed Clip in the middle of each section and all other at a maximum repeat distance of 400 mm. Install the last clips 100 mm from the end of the section. Install the clips with the arrows pointing up and the word TOP readable.

6. Distance between sections:

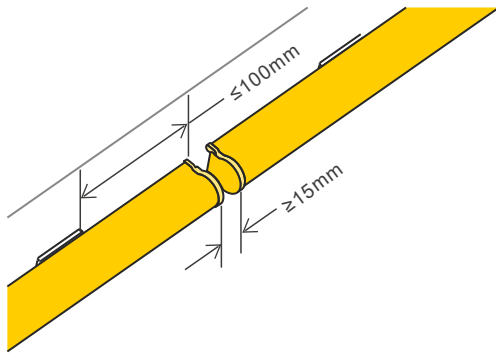

To allow for thermal expansion and contraction and to prevent damage the individual sections need to have a gap between them. Later covered with a joint cover.
When installing at an ambient temperature below 10 °C leave a minimum gap of 15 mm between sections. Above 10 °C this can be 10 mm.

8. JST Connectors:

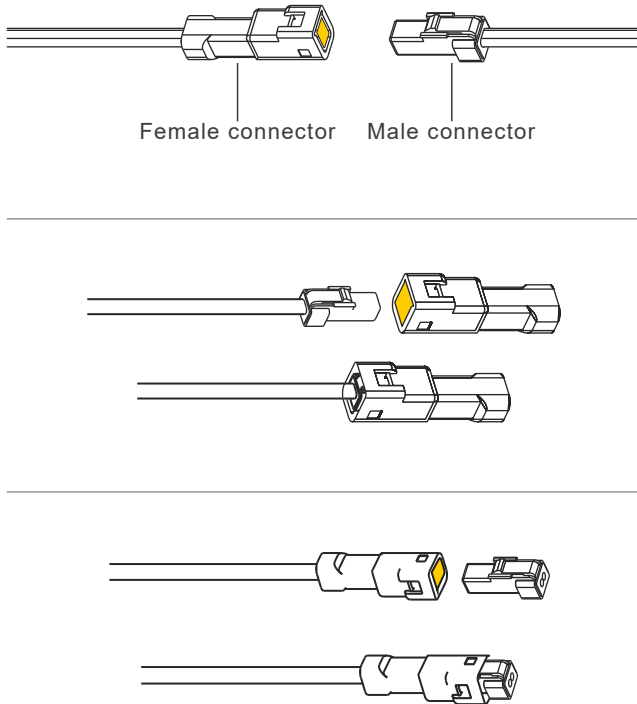

The JST connectors have a locking clip. Make sure these are fully engaged, making the connection IP67 water proof. Hide the connectors behind the tubes once connected. Do not pull or bend the cables too tight. This may damage the seal and compromise the IP rating.
To close off all open connectors in an installation and make them waterproof male or female blanking connectors must be used. Otherwise water can get into the open connectors which will lead to failures.

7. Corners:

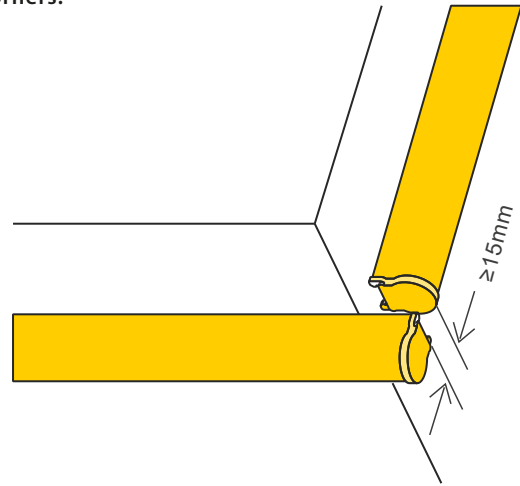

To install a corner on 2 sections these should overlap each other so that the end of the section is flush with the top of the other section. Again leave a gap as in the drawing to allow for thermal expansion. Snap the corner over the 2 sections to fix it.

9. Installation of corners:

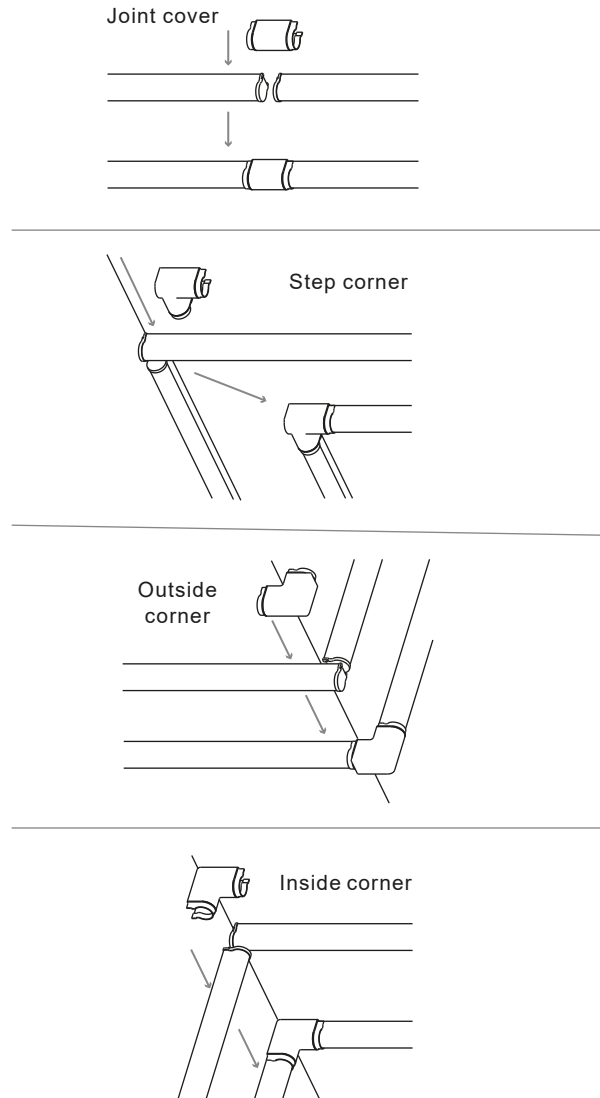

CUTTING

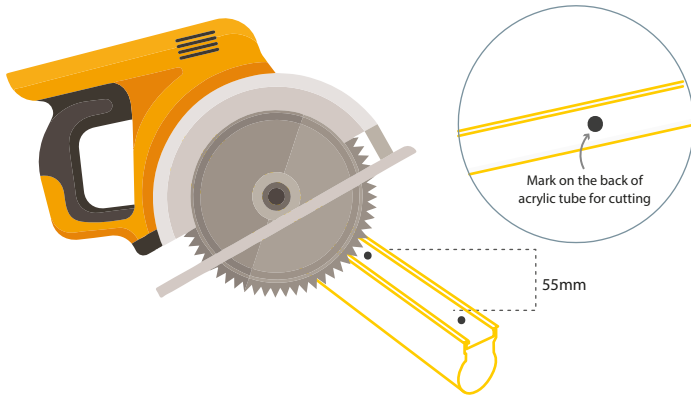

1. Cutting of the tubes: Locate the cutting positions (black dots) at the back of the tubes placed at every 55mm apart. Align the cutting position with the middle of the saw blade, place the tube flat on the platform, and cut the tube perpendicular to the saw blade. Please make sure that the saw blade is sharp to ensure that the cutting end face is smooth.

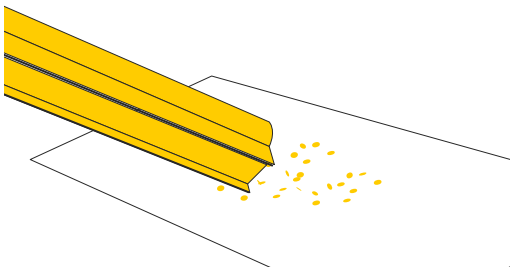

2. Clean inside tube from plastic and aluminium residue.

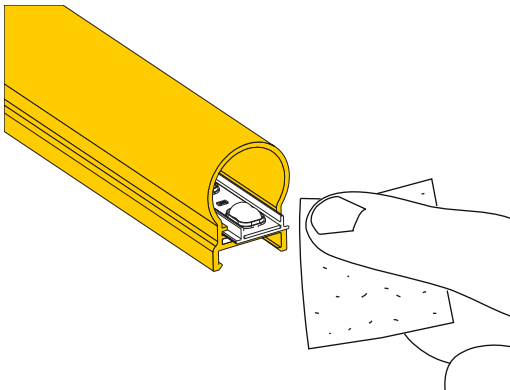

3. Sand the edge: Sand the edge of the tube & the PCB with the fine sand paper to ensure the edge is smoothed & uniform. Push back the PCB inside the tube.

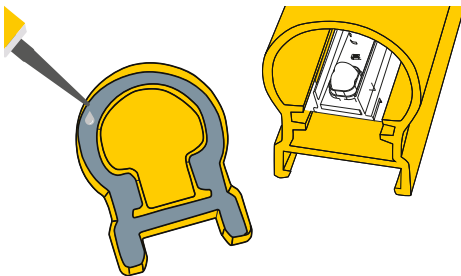

4. Fix end cap: Fill the edge of the cap with PMMA glue (Weldon 16, Acryfix or similar). Push it on the tube and hold for 30 seconds.

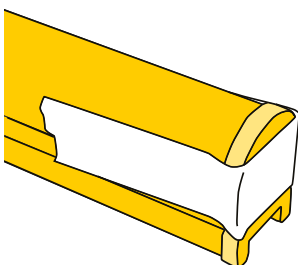

5. Fix a tape to cure: Put a piece of masking tape over the end cap and tube and let it cure for at least 20 minutes before handling it.



BELGIUM

Industriepark 32b
3290 Diest
Belgium

www.lucoled.com

P: +32 (0) 13292829
E: info@lucoled.com

THE NETHERLANDS

Rotterdamseweg 388F
2629 HG Delft
The Netherlands