

# INDOOR SIGNAGE



COSIGN

MODULAR SIGN SYSTEMS & WAY FINDING SOLUTIONS

## INTERIOR / INTERIEUR

### FLEXIBLE

I-SIGN FLEX	04
I-SIGN FIX	08
I-SIGN ECO	12
I-FLAG	16
I-SIGN DISPLAY / DISPLAY SLIM	18
STRATO	22
CURVO PLUS	28

### MODULAR

MODULE PLUS INDOOR	32
--------------------	----

### LED SIGNS

INDOOR LIGHTBOX	38
SOLED	40
LED LIGHT SHEETS	42

### TEXTILE FRAMES

SINGLE & DOUBLE SIDED	44
-----------------------	----

### FIXINGS & SUSPENSION

INOX & ALUMINIUM FIXINGS	50
SUSPENSION KITS	56

HIGH QUALITY  
CUSTOMISATION

INNOVATION

LARGE STOCK

EXPERIENCE

FLEXIBLE

SERVICE

QUALITÉ SUPÉRIEURE

PERSONNALISATION

INNOVATION

GRAND STOCK

EXPÉRIENCE

FLEXIBLE

SERVICE

**COSIGN**  
MODULAR SIGN SYSTEMS



#### YOUR GLOBAL PARTNER IN SIGN

Cosign was established in 1993. Over the last 30 years it has become the unsurpassed reference with regard to architectural signage.

No matter what type of signs you need, for indoor or outdoor use, flexible or modular, with or without LED technology, if desired with fabric, advertising pillars or spacers, Cosign is the right address.

Cosign is a global player with production facilities and distribution centres in Belgium (headquarters), India, Mexico, Brazil and Hong Kong.

Our extensive range of products is unique. We are able to deliver quickly due to our large supply of stock. 30 years of experience, well-organised logistical transactions and perfect service make Cosign a reliable partner that you can trust.

Cosign constantly works on innovative solutions for the sign industry together with top designers like Stefan Schöning, Bart Bauwens (IDnA) and Fabrique.

#### VOTRE PARTENAIRE MONDIAL POUR LA SIGNALISATION

Cosign a été fondé en 1993 et au cours de ces 30 dernières années l'entreprise s'est transformée en une référence mondiale dans la signalisation architecturale.

Quel que soit le type de signalisation que vous recherchez - pour une application d'intérieur ou d'extérieur, flexible ou modulaire, avec ou sans technologie LED, avec ou sans toiles de textile, des totems publicitaires ou des entretoises - chez Cosign vous êtes certain d'être à la bonne enseigne.

Cosign est devenu un acteur de classe mondiale avec des facilités de production et de distribution en Belgique (siège principal), en Inde, au Mexique, Brésil et à Hong Kong.

Notre vaste gamme de produits n'est ni plus ni moins qu'unique. Grâce à notre grand stock nous sommes toujours en mesure de livrer rapidement. En sus de nos 30 années d'expérience, notre traitement logistique bien organisé et notre service parfait font que Cosign est un partenaire fiable sur lequel vous pouvez toujours compter.

Epaulé de designers de renom comme Stefan Schöning, Bart Bauwens (IDnA) et Fabrique, Cosign est sans cesse à la recherche de solutions innovantes pour l'industrie de la signalisation.

# I-SIGN FLEX



[www.cosign.be/isignflex](http://www.cosign.be/isignflex)

I-Sign Flex is an intelligent, modern sign system with a few unique characteristics:

1. The top of the acrylic cover plate is at the same level as the top of the aluminium frame with a visible rim of only 2.5 mm.
2. The I-Sign Flex comes with a spring system; this makes it very easy to remove the acrylic plate and replace the insert.
3. When mounting on a wall you can use double-sided tape or adjustable mount buttons.
4. The I-Sign Flex has a lock function to prevent vandalism.

I-Sign Flex est un système de signalisation intelligent et moderne avec quelques caractéristiques uniques:

1. Le dessus de la plaquette de couverture en acrylate se situe dans le même plan que le dessus du châssis en aluminium avec un petit bord visible d'à peine 2,5 mm.
2. L'I-Sign Flex est équipé d'un système à ressort qui facilite le retrait de la plaquette en acrylate afin de remplacer l'encart.
3. Pour un montage mural on peut utiliser aussi bien de la bande adhésive double face que des capuchons muraux adaptables.
4. Pour contrer les actes de vandalisme, l'I-Sign Flex est équipé d'une fonction de sécurité.

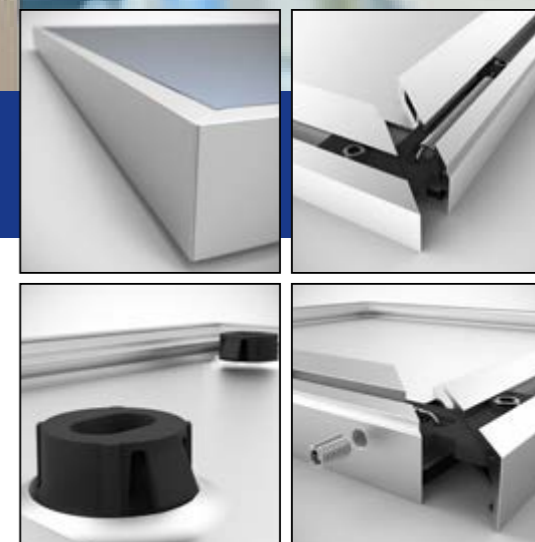

PROFILES & ACCESSORIES

CUSTOM MADE

READY MADE

## STANDARD SIZES

### DIMENSIONS STANDARD

#### WALL MOUNTED FIXATION MURALE



product code	insert (hwx) in mm / insert (hxl) en mm
I-052148-W	52 x 148,5
I-060210-W	60 x 210
I-105107-W	105 x 107
I-105148-W	105 x 148,5 (DIN A6)
I-105148-WS	105 x 148,5 (DIN A6 slider)
I-148150-W	148,5 x 150,5
I-210148-W	210 x 148,5 (DIN A5)
I-210212-W	210 x 212
I-210297-W	210 x 297 (DIN A4 landscape)
I-297210-W	297 x 210 (DIN A4 portrait)
I-297299-W	297 x 299
I-420297-W	420 x 297 (DIN A3 portrait)
I-594420-W	594 x 420 (DIN A2)
I-841594-W	841 x 594 (DIN A1)

NEW



product code	insert (hwx) in mm / insert (hxl) en mm
I-052148-W-B	52 x 148,5
I-060210-W-B	60 x 210
I-105107-W-B	105 x 107
I-105148-W-B	105 x 148,5 (DIN A6)
I-105148-WS-B	105 x 148,5 (DIN A6 slider)
I-148150-W-B	148,5 x 150,5
I-210148-W-B	210 x 148,5 (DIN A5)
I-210212-W-B	210 x 212
I-210297-W-B	210 x 297 (DIN A4 landscape)
I-297210-W-B	297 x 210 (DIN A4 portrait)
I-297299-W-B	297 x 299
I-420297-W-B	420 x 297 (DIN A3 portrait)
I-594420-W-B	594 x 420 (DIN A2)
I-841594-W-B	841 x 594 (DIN A1)

#### TABLE STAND PRÉSENTOIR DE TABLE



NEW

product code	insert (hwx) in mm / insert (hxl) en mm
I-052148-T	52 x 148,5
I-052148-T-B	52 x 148,5

#### SUSPENDED SYSTÈME DE SUSPENSION



product code	insert (hwx) in mm / insert (hxl) en mm
I-148297-S	148,5 x 297
I-148420-S	148,5 x 420
I-148600-S	148,5 x 600
I-148840-S	148,5 x 840
I-210297-S	210 x 297
I-210420-S	210 x 420
I-210600-S	210 x 600
I-210840-S	210 x 840

NEW



product code	insert (hwx) in mm / insert (hxl) en mm
I-148297-S-B	148,5 x 297
I-148420-S-B	148,5 x 420
I-148600-S-B	148,5 x 600
I-148840-S-B	148,5 x 840
I-210297-S-B	210 x 297
I-210420-S-B	210 x 420
I-210600-S-B	210 x 600
I-210840-S-B	210 x 840

#### PROJECTED FIXATION EN DRAPEAU



product code	insert (hwx) in mm / insert (hxl) en mm
I-150148-P	150,5 x 148,5
I-212210-P	212 x 210
I-210297-P	210 x 297
I-297210-P	297 x 210

NEW



product code	insert (hwx) in mm / insert (hxl) en mm
I-150148-P-B	150,5 x 148,5
I-212210-P-B	212 x 210
I-210297-P-B	210 x 297
I-297210-P-B	297 x 210

## PROFILES & ACCESSORIES

### PROFILÉS & ACCESSOIRES

#### PROJECTING PROFILE PROFILÉ À ANGLE DROIT

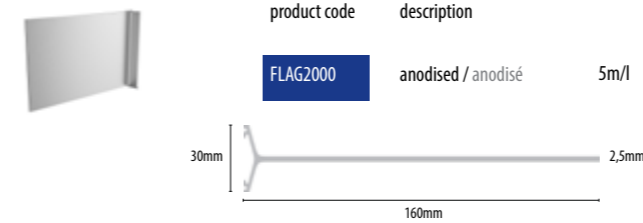

product code	description
FLAG2000	anodised / anodisé 5m/l

#### SUCTION CUP / VENTOUSE



product code
VACUUMC2

#### HANGING CLIP / CLIP DE SUSPENSION



product code
APC-3000S

#### PROJECTING BRACKET SUPPORT DE MONTAGE EN DRAPEAU



product code
I-BRACKET

#### HANGING KIT / KIT DE SUSPENSION



product code	description
APC4101	2x conical clip + 1,5m wire 2x clip conique + 1,5m fil

See also page 52 for more suspension systems.  
Pour plus d'infos sur les systèmes de suspension, voyez également sur la page 52.



# I-SIGN FIX



[www.cosign.be/isignfix](http://www.cosign.be/isignfix)

The sleek design of the I-Sign range is extended to the I-Sign Fix; observe the elegant frame with invisible fixings.

Sheets of only 2 or 3 mm thick are mounted in the frame with a small, innovative clip. The sheets can be made from various materials: PVC, ACM, acrylic, aluminium, engraving materials, etc. This results in a high degree of personalisation.

Le design élégant de la gamme I-Sign, sans fixation apparente, se retrouve également chez l'I-Sign Fix.

A l'aide d'un petit clip innovant les plaquettes d'une épaisseur de 2 ou 3 mm sont fixées sur le châssis. Différents matériaux peuvent être utilisés pour les plaques : PVC, ACM, acrylate, aluminium, matériaux à graver, etc., permettant un degré élevé de personnalisation.

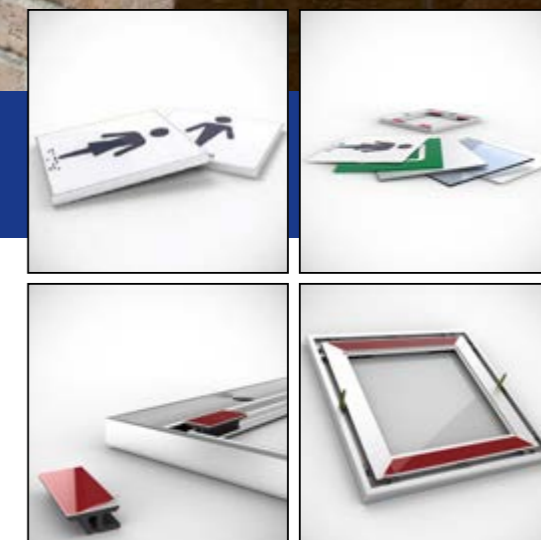

## STANDARD SIZES

### DIMENSIONS STANDARD

#### WALL MOUNTED FIXATION MURALE



product code	insert (hwx) in mm / insert (lxh) en mm
IF-150150-W	150 x 150
IF-150300-W	150 x 300
IF-150600-W	150 x 600
IF-297210-W	297 x 210 (DIN A4)
IF-297420-W	297 x 420 (DIN A3)

NEW



IF-150150-W-B	150 x 150 - Black
IF-150300-W-B	150 x 300 - Black
IF-150600-W-B	150 x 600 - Black
IF-297210-W-B	297 x 210 (DIN A4) - Black
IF-297420-W-B	297 x 420 (DIN A3) - Black

#### PROJECTED FIXATION EN DRAPEAU



product code	insert (hwx) in mm / insert (lxh) en mm
IF-150150-P	150 x 150
IF-150300-P	150 x 300

NEW



IF-150150-P-B	150 x 150 - Black
IF-150300-P-B	150 x 300 - Black

I-FLAG	150 x 161
--------	-----------

#### SUSPENDED SYSTÈME DE SUSPENSION

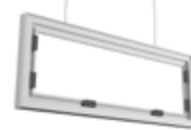

product code	insert (hwx) in mm / insert (lxh) en mm
IF-150150-S	150 x 150
IF-150300-S	150 x 300
IF-150600-S	150 x 600

NEW



IF-150150-S-B	150 x 150 - Black
IF-150300-S-B	150 x 300 - Black
IF-150600-S-B	150 x 600 - Black

#### SUCTION CUP / VENTOUSE



product code

VACUUMC2

#### CONNECTOR / CONNECTEUR



product code

I-CONNECTOR

## PROFILES & ACCESSORIES

### PROFILÉS & ACCESSOIRES

#### ALUMINIUM PROFILES PROFILÉS ALUMINIUM



product code	description	
IF-WM1000	mill finish / brut	5m/l
IF-WM2000	anodised / anodisé	5m/l
IF-WM5000	black anodised / anodisé noir	5m/l



product code	description	
IF-SP1000	mill finish / brut	5m/l
IF-SP2000	anodised / anodisé	5m/l
IF-SP5000	black anodised / anodisé noir	5m/l



product code	description	
FLAG2000	anodised / anodisé	5m/l

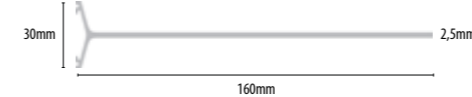

#### CORNER SECTION / PIÈCE D'ANGLE



product code

IF-CORNER

#### PROJECTING BRACKET SUPPORT DE MONTAGE EN DRAPEAU



product code

I-BRACKET

#### MOUNTING CLIP / CLIP DE FIXATION



product code

I-CLIP

#### HANGING CLIP / CLIP DE SUSPENSION



product code

APC-3000S

#### HANGING KIT / KIT DE SUSPENSION



product code description

APC-CABLE-1.5 Galvanized cable (7x7) 1,5m length with 4,5mm ball nipple

See also page 52 for more suspension systems.  
Pour plus d'infos sur les systèmes de suspension, voyez également sur la page 52.



FLEXIBLE

# I-SIGN ECO

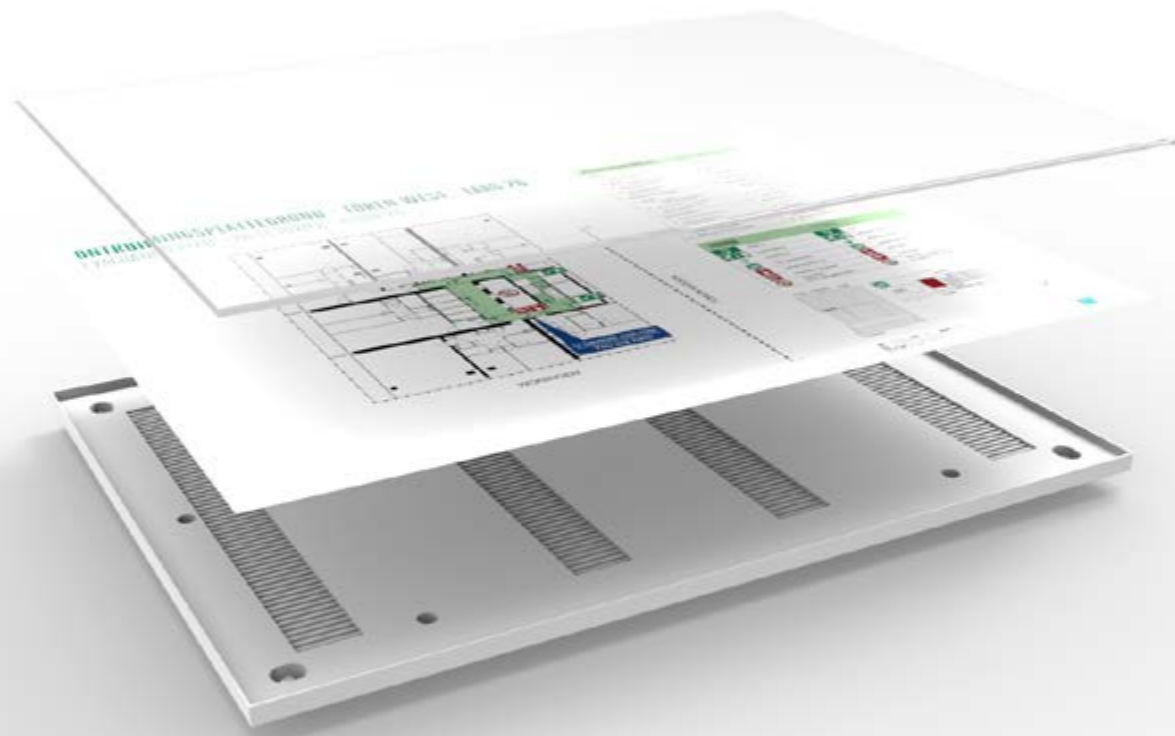

[www.cosign.be/i-sign-eco](http://www.cosign.be/i-sign-eco)

I-Sign Eco is the newest member of the I-Sign family. I-Sign Eco maintains the same sleek design with the thin edge which became so typical for the entire I-Sign range.

It is possible to create single-sided wall mounting or double-sided suspended or flag mounting signs.

I-Sign Eco est le produit le plus récent de notre gamme I-Sign. I-Sign Eco conserve le même design moderne avec une fine bordure, typiquement pour toute la gamme I-Sign.

Il est possible de créer des enseignes de montage mural (simple face), suspendues au plafond (double face) ou fixation en drapeau (double face).



CUSTOM MADE READY MADE

## One Frame, Two Functions

## Un Cadre, Deux Fonctions

The user can choose between a flexible version with a paper inlay behind a non-reflecting acrylic cover, or a more fixed version with 2 or 3mm thick sheets in different materials like PVC, ACM, acrylic or aluminium which allow for a highly customized solution.

L'utilisateur peut choisir entre une version flexible avec une feuille de papier derrière une face acrylique non réfléchissante, et une version plus fixe avec des plaques de 2 ou 3 mm d'épaisseur dans différents matériaux comme le PVC, l'ACM, l'acrylique ou l'aluminium, ce qui permet une solution hautement personnalisée.

### I-SIGN ECO FIX

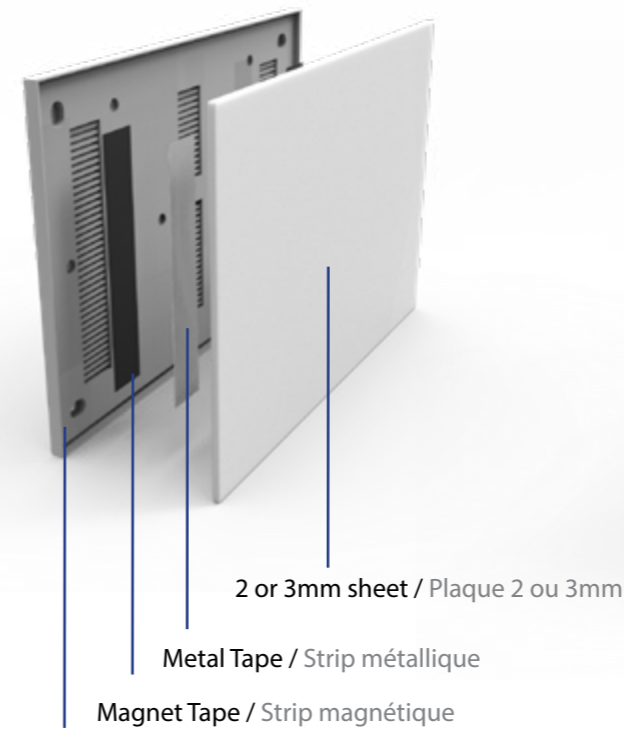

I-Sign Eco frame / Cadre I-Sign Eco

### I-SIGN ECO FLEX

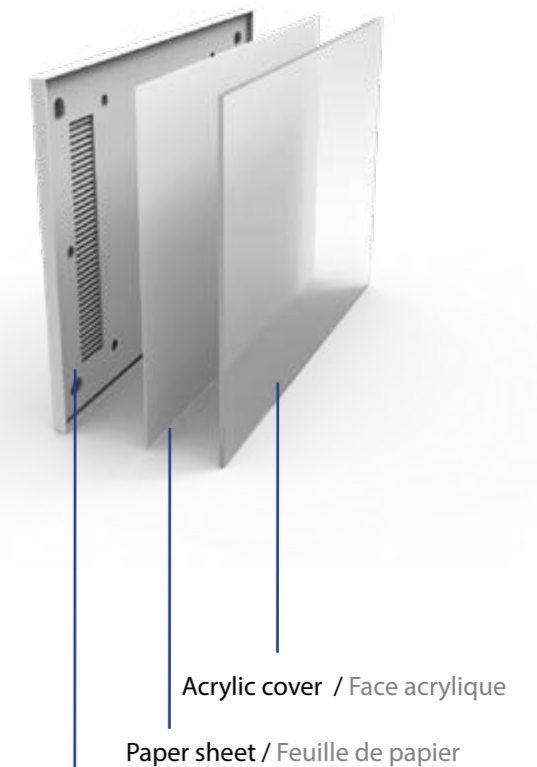

I-Sign Eco frame / Cadre I-Sign Eco

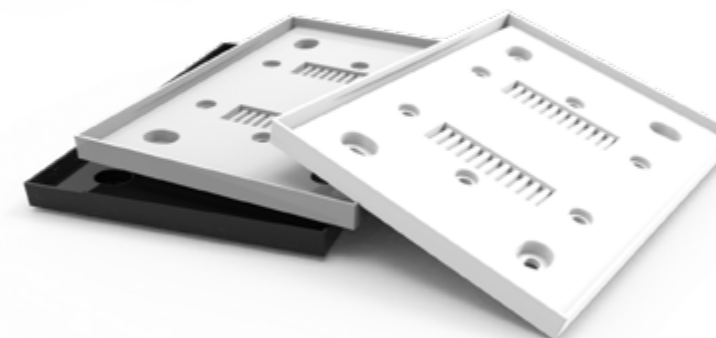

The frames, which are available in sizes DIN A6, DIN A5, DIN A4, DIN A3, 150x150mm and 150x300mm, are injection molded in abs plastic and are available in different colors.

Standard colors are aluminium grey and black.

Les cadres, disponibles en DIN A6, DIN A5, DIN A4, DIN A3, 150x150mm et 150x300mm, sont moulés en plastique ABS (processus d'injection) et disponibles en différentes couleurs.

Les couleurs standard sont gris aluminium et noir.

## I-SIGN ECO FLEX

### WALL MOUNTED / FIXATION MURALE

I-Sign Eco Flex Wall Mounted. Included: I-Sign Eco Frame, Acrylic cover.

I-Sign Eco Fixation Murale. Inclus: Cadre I-Sign Eco, Face acrylique.



product code	insert (hwx) in mm
IE-150150-W-X	150 x 150
IE-150300-W-X	150 x 300
IE-105148-W-X	105 x 148,5 (DIN A6)
IE-210148-W-X	210 x 148,5 (DIN A5)
IE-210297-W-X	210 x 297 (DIN A4)
IE-420297-W-X	420 x 297 (DIN A3)

**X = colour code:**

W: White, B: Black, G: Grey  
(Other colours available on request.)

**X = Code de couleur:**

W: Blanc, B: Noir, G: Gris  
(Autres couleurs disponibles sur demande.)

### PROJECTED / FIXATION EN DRAPEAU

I-Sign Eco Flex Projected. Fully assembled including: 2x I-Sign Eco Frames, Connection Pins, Interior Cover, Flag system, Acrylic covers.

I-Sign Eco Fixation en Drapeau. Entièrement assemblé inclus: 2x Cadre I-Sign Eco, Connexions, Couverture l'intérieur, Système en drapeau, Faces acryliques.

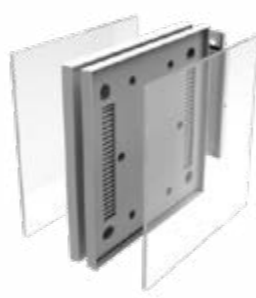

product code	insert (hwx) in mm
IE-150150-P-X	150 x 150
IE-150300-P-X	150 x 300
IE-210297-P-X	210 x 297 (DIN A4 landscape)
IE-297210-P-X	297 x 210 (DIN A4 portrait)

**X = colour code:**

W: White, B: Black, G: Grey  
(Other colours available on request.)

**X = Code de couleur:**

W: Blanc, B: Noir, G: Gris  
(Autres couleurs disponibles sur demande.)

## I-SIGN ECO FIX

### WALL MOUNTED / FIXATION MURALE

I-Sign Eco Flex Wall Mounted. Included: I-Sign Eco Frame.

I-Sign Eco Fixation Murale. Inclus: I-Sign Eco Cadre.

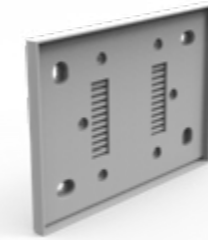

product code	insert (hwx) in mm
IFE-150150-W-X	150 x 150
IFE-150300-W-X	150 x 300
IFE-105148-W-X	105 x 148,5 (DIN A6)
IFE-210148-W-X	210 x 148,5 (DIN A5)
IFE-210297-W-X	210 x 297 (DIN A4)
IFE-420297-W-X	420 x 297 (DIN A3)

**X = colour code:**

W: White, B: Black, G: Grey  
(Other colours available on request.)

**X = Code de couleur:**

W: Blanc, B: Noir, G: Gris  
(Autres couleurs disponibles sur demande.)

### PROJECTED / FIXATION EN DRAPEAU

I-Sign Eco Flex Projected. Fully assembled including: 2x I-Sign Eco Frames, Connection Pins, Interior Cover, Flag system.

I-Sign Eco Fixation en Drapeau. Entièrement assemblé inclus: 2x I-Sign Eco Cadre, Couverture l'intérieur, Système en drapeau.

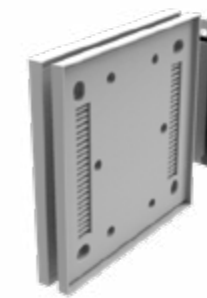

product code	insert (hwx) in mm
IFE-150150-P-X	150 x 150
IFE-150300-P-X	150 x 300
IFE-210297-P-X	210 x 297 (DIN A4 landscape)
IFE-297210-P-X	297 x 210 (DIN A4 portrait)

**X = colour code:**

W: White, B: Black, G: Grey  
(Other colours available on request.)

**X = Code de couleur:**

W: Blanc, B: Noir, G: Gris  
(Autres couleurs disponibles sur demande.)

### SUSPENDED / SYSTÈME DE SUSPENSION

I-Sign Eco Flex Suspended. Included: 2x I-Sign Eco Frames, Connection Pins, Interior Cover, Suspension cables, Acrylic covers.

I-Sign Eco Flex Systeme de suspension. Entièrement assemblé inclus: 2x Cadres I-Sign Eco, Connexions, Couverture l'intérieur, Fils de suspension, Faces acryliques.

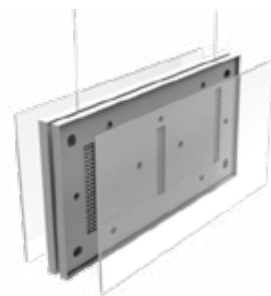

product code	insert (hwx) in mm
IE-150150-S-X	150 x 150
IE-150300-S-X	150 x 300
IE-210297-S-X	210 x 297 (DIN A4 landscape)
IE-297210-S-X	297 x 210 (DIN A4 portrait)

**X = colour code:**

W: White, B: Black, G: Grey  
(Other colours available on request.)

**X = Code de couleur:**

W: Blanc, B: Noir, G: Gris  
(Autres couleurs disponibles sur demande.)

See also page 52 in our architectural brochure for more suspension systems.

Voir également page 52 dans notre brochure architectural pour plus d'infos sur nos systèmes de suspension.

## ACCESSORIES / ACCESSOIRES

product code	description
IE-CONNECTOR	Connector to combine two I-Sign Eco frames. Connexion pour connecter deux cadre I-Sign Eco.
APC-3000-S	Suspension Clip. Clip de suspension.
APC-CABLE-1.5	1.5mm thick galvanized cable (7x7). 1,5m length with 4,5mm ball nipple. 1,5mm fil galvanisé (7x7) 1,5m de longueur avec un téton sphérique de 4,5mm de diamètre.
I-FLAG3-100	I-Flag 3 profile with mount 100mm I-Flag 3 profilé avec support 100mm
I-FLAG3-150	I-Flag 3 profile with mount 150mm I-Flag 3 profilé avec support 150mm

## ACCESSORIES / ACCESSOIRES

product code	description
IE-COV150150	Cover to hide I-Sign Eco frame interior. For 150x150mm projected. Couverture pour cacher l'intérieur de l'assemblage Pour 150x150mm fixation en drapeau
IE-COV150300	Cover to hide I-Sign Eco frame interior. For 150x300mm suspended. Couverture pour cacher l'intérieur de l'assemblage Pour 150x300mm système de suspension
IE-COV300150	Cover to hide I-Sign Eco frame interior. For 150x300mm projected Couverture pour cacher l'intérieur de l'assemblage Pour 300x150mm fixation en drapeau
IE-COV210297	Cover to hide I-Sign Eco frame interior. For 210x297mm suspended Couverture pour cacher l'intérieur de l'assemblage Pour 150x150mm système de suspension
IE-COV297210	Cover to hide I-Sign Eco frame interior. For 210x297mm projected Couverture pour cacher l'intérieur de l'assemblage Pour 150x150mm fixation en drapeau

### SUSPENDED / SYSTÈME DE SUSPENSION

I-Sign Eco Flex Suspended. Included: 2x I-Sign Eco Frames, Connection Pins, Interior Cover, Suspension cables.

I-Sign Eco Flex Systeme de suspension. Entièrement assemblé inclus: 2x Cadres I-Sign Eco, Couverture l'intérieur, Connexions, Fils de suspension.

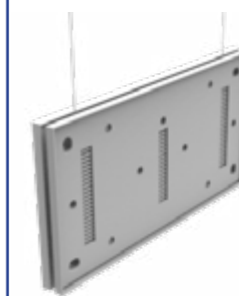

product code	insert (hwx) in mm
IFE-150150-S-X	150 x 150
IFE-150300-S-X	150 x 300
IFE-210297-S-X	210 x 297 (DIN A4 landscape)
IFE-297210-S-X	297 x 210 (DIN A4 portrait)

**X = colour code:**

W: White, B: Black, G: Grey  
(Other colours available on request.)

**X = Code de couleur:**

W: Blanc, B: Noir, G: Gris  
(Autres couleurs disponibles sur demande.)

See also page 52 in our architectural brochure for more suspension systems.

Voir également page 52 dans notre brochure architectural pour plus d'infos sur nos systèmes de suspension.

## FLEXIBLE

# I-FLAG



[www.cosign.be/iflag](http://www.cosign.be/iflag)

Cosign developed a universal FLAG profile which can be used as a stand-alone product, to be mounted directly to the wall or ceiling, or in combination with other Cosign products like the I-Sign Eco, I-Sign Flex or I-Sign Fix frames.

First an aluminium mounting profile is fixed to the wall or ceiling, then the flag profile with or without frames mounted on it is slid over the mounting profile and fixed with a set screw.

Cosign a développé un profil, qui s'appelle I-FLAG2 et qui peut être utilisé comme produit autonome - pour être monté directement sur le mur ou le plafond - ou en combinaison avec d'autres produits Cosign comme les cadres I-Sign Eco, I-Sign Flex ou I-Sign Fix.

Tout d'abord, un profil de montage en aluminium est fixé au mur ou au plafond, puis le profil de drapeau - avec ou sans cadres montés dessus - est glissé sur ce profilé de montage et fixé avec une vis de réglage.



PROFILES & ACCESSORIES  
COSIGN

CUSTOM MADE  
COSIGN

READY MADE  
COSIGN

## STANDARD SIZES

### DIMENSIONS STANDARD

#### I-FLAG 1

Standalone or in combination with I-Sign Fix/ Flex  
Autonome ou en combinaison avec I-Sign Fix/ Flex



product code

I-FLAG1

I-Flag 1 with mount 150mm  
I-Flag 1 profilé avec support 150mm

#### I-FLAG 2

Standalone  
Autonome



product code

I-FLAG2-150

I-Flag 2 with mount 150mm  
I-Flag 2 profilé avec support 150mm  
I-FLAG2-300  
I-Flag 2 with mount 300mm  
I-Flag 2 profilé avec support 300mm

## PROFILES & ACCESSORIES

### PROFILÉS & ACCESSOIRES

#### FLAG1-2000

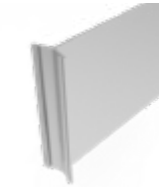

product code

FLAG1-2000

anodised / anodisé

5m/l

#### PROJECTING BRACKET SUPPORT DE MONTAGE EN DRAPEAU



product code

I-BRACKET

Bracket for Flag1-2000  
Support pour Flag1-2000

#### FLAG2-2000



product code

FLAG2-2000

anodised / anodisé

5m/l

#### MOUNT2-1000



product code

MOUNT2-1000

mill finish / brut

5m/l

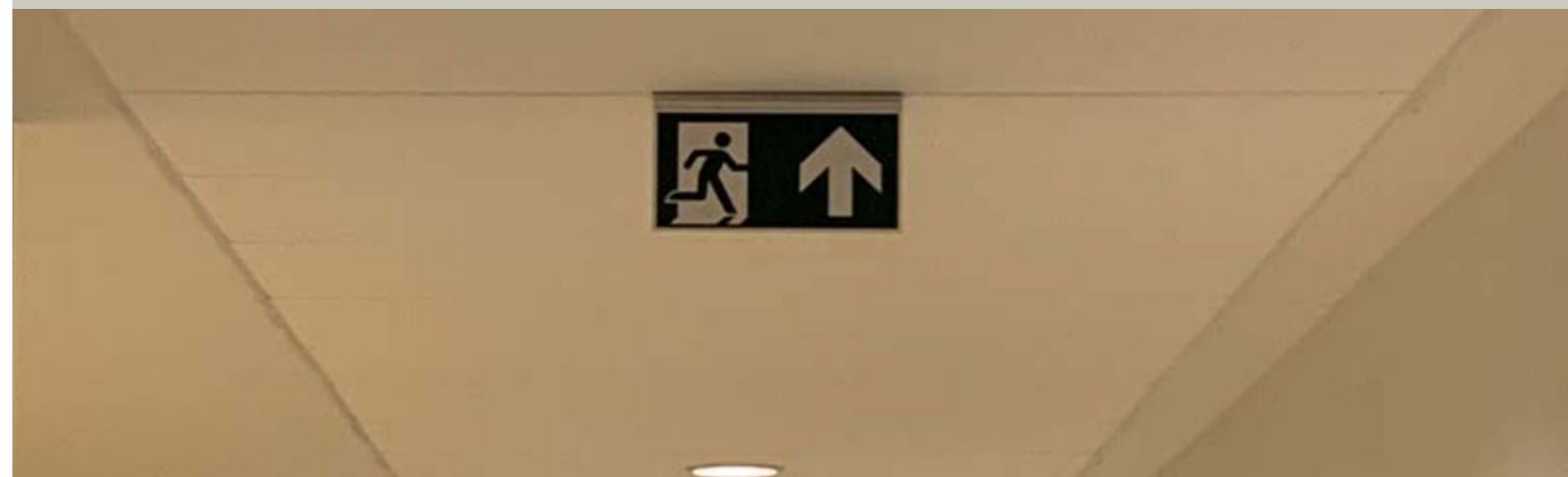

# I-SIGN DISPLAY



[www.cosign.be/isigndisplay](http://www.cosign.be/isigndisplay)

The single-sided I-Sign Display profiles make it possible to frame large panels, digital prints and art virtually without an edge and without visible fixings. This makes them very suitable for use in museums, galleries and interior decoration.

The double-sided profile is extremely suitable for making thin light boxes and illuminated or non-illuminated indoor pillars.

Double-sided tape, magnetic tape or the 3M Dual Lock™ reclosable fastener can be used to affix the panels.

Les profils I-Sign Display à simple face permettent d'encadrer pratiquement sans bords les grands panneaux, les impressions numériques et les affiches artistiques, ce qui les rend appropriés pour des applications dans les musées, les galeries et pour les décorations d'intérieur.

Le profil à double face convient tout particulièrement pour la réalisation de caissons lumineux minces et de petites colonnes d'intérieur, avec ou sans éclairage.

Pour la fixation des panneaux il est possible d'utiliser aussi bien des bandes magnétiques que du Velcro ou le Dual Lock™ refermable de 3M ou bien des bandes adhésives double face.



## SINGLE-SIDED

### SIMPLE FACE

#### ALUMINIUM PROFILE / PROFILÉ ALUMINIUM

product code	description	
ID-SS1000	mill finish / brut	5m/l
ID-SS2000	anodised / anodisé	5m/l
ID-SS5000	black anodised / anodisé noir	5m/l

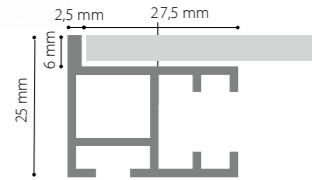

#### CORNER CONNECTOR / RACCORD D'ANGLE



product code
ID-SS CORNER

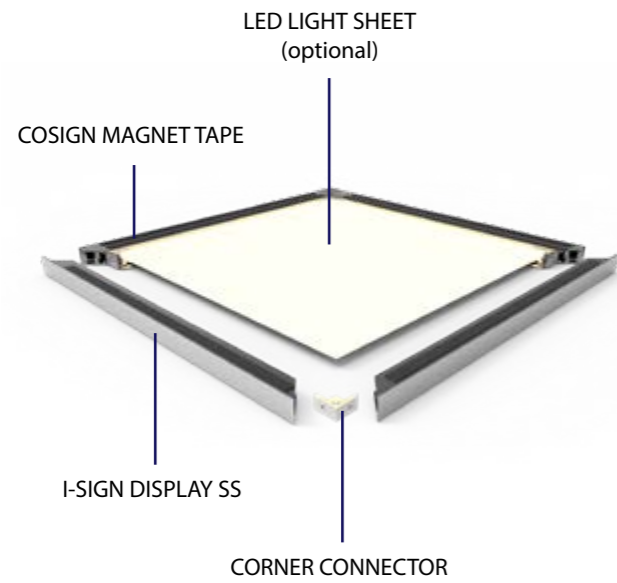

## DOUBLE-SIDED SLIM

### DOUBLE FACE SLIM

#### ALUMINIUM PROFILE / PROFILÉ ALUMINIUM

product code	description	
ID-SLIM1000	mill finish / brut	5m/l
ID-SLIM2000	anodised / anodisé	5m/l

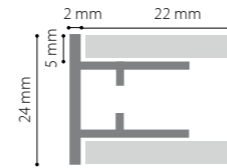

#### CORNER CONNECTOR / RACCORD D'ANGLE



product code
ID-SL CORNER

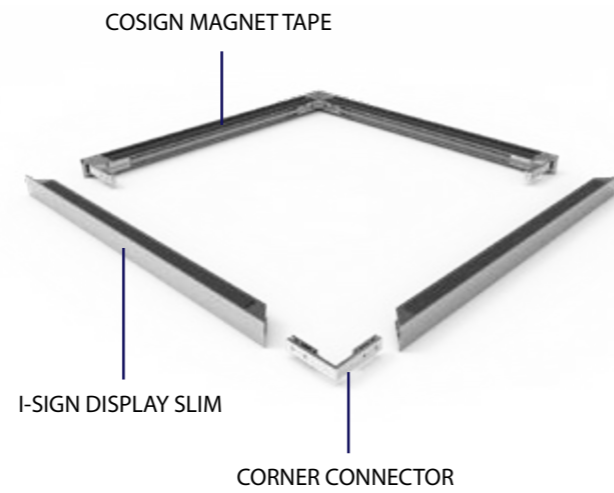

## DOUBLE-SIDED

### DOUBLE FACE

#### ALUMINIUM PROFILE / PROFILÉ ALUMINIUM

product code	description	
ID-DS1000	mill finish / brut	5m/l
ID-DS2000	anodised / anodisé	5m/l
ID-DS5000	black anodised / anodisé noir	5m/l

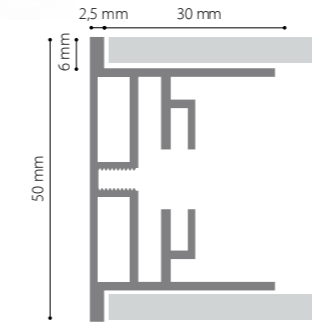

#### CORNER CONNECTOR / RACCORD D'ANGLE

product code
ID-DS CORNER

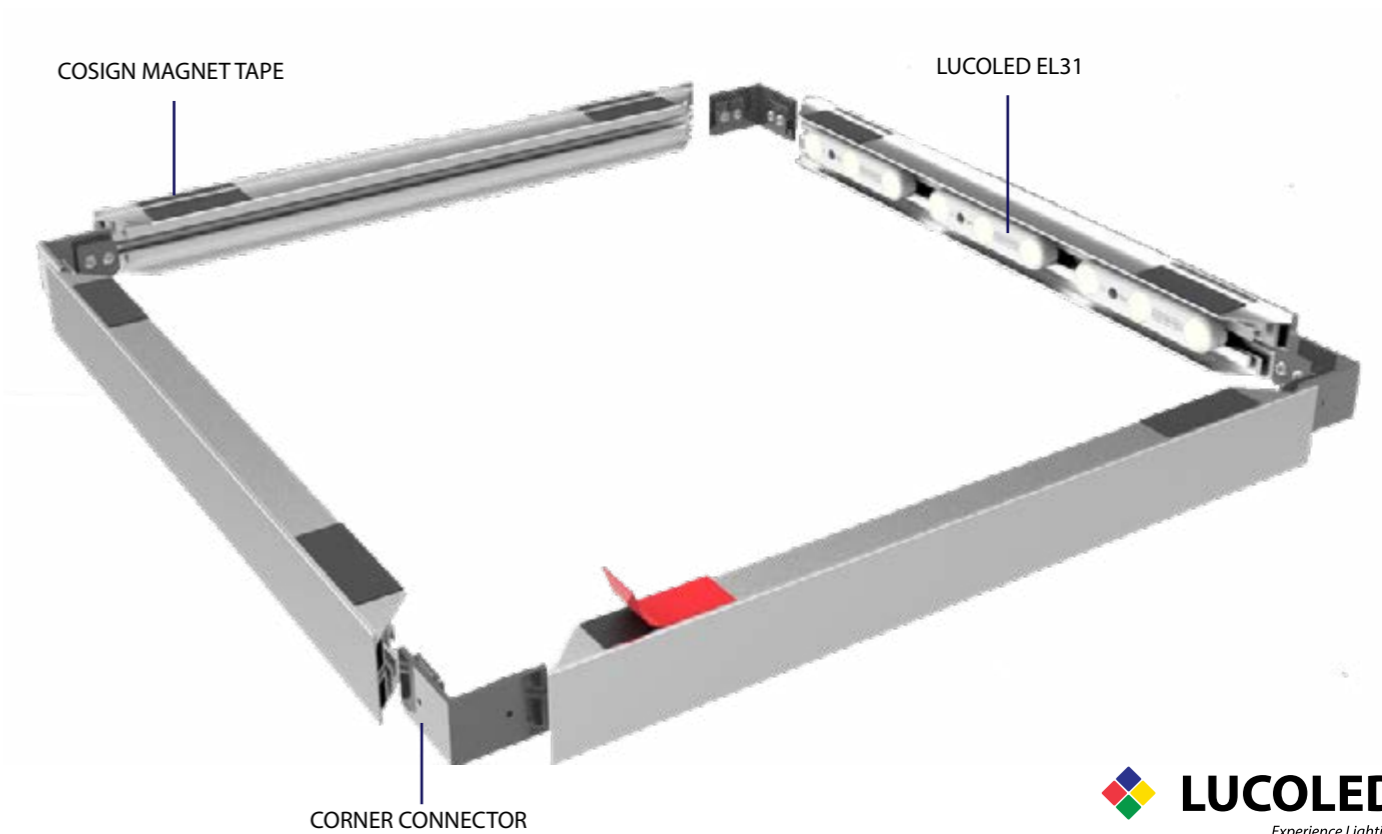

## MAGNETIC STRIPS / STRIPS MAGNÉTIQUES



product code	description	
MAGI12.7/1.5A5	Isotropic A, 5 poles	12,7 x 1,5 mm
MAGI12.7/1.5B5	Isotropic B, 5 poles	12,7 x 1,5mm
MAGI25.4/1.5A9	Isotropic A, 9 poles	25,4 x 1,5mm
MAGI25.4/1.5B9	Isotropic B, 9 poles	25,4 x 1,5mm
MAGI12.7/1.0A5	Anisotropic A, 5 poles	12,7 x 1mm
METAL13	Metal strip	13 x 0,22mm
METAL25	Metal strip	25 x 0,22mm

## LUCOLED EL31



product code	description
EL31-W65	12 VDC 327lm / module 2,88W / module

## POWER SUPPLY / SOURCE D'ALIMENTATION



product code	description
PPS1230	Lucoled Slim 12 VDC / 30W
PPS1260	Lucoled Slim 12 VDC / 60W
PPS12100	Lucoled Slim 12 VDC / 100W
PP12150	Lucoled 12 VDC / 150W
PP12200	Lucoled 12 VDC / 200W

# STRATO



[www.cosign.be/strato](http://www.cosign.be/strato)

STRATO is a flexible and contemporary sign system consisting of a series of soft curved profiles with square sides.

A paper inlay (in the most common DIN formats) can be inserted in the profiles behind a non-reflecting acrylic cover. Other inserts in plastic or metal are of course also possible as well as direct signage or printing on the profiles.

The user can choose between plastic and aluminium end caps for the finish. Recently, a few profiles and end caps were added to the range that ensure that 400 mm, 500 mm and 600 mm wide directories can be produced.

STRATO est un système de signalisation flexible et contemporain qui se compose d'une série de profilés légèrement galbés avec des côtés rectilignes.

Les profilés peuvent accueillir un support de données en papier (dans les formats DIN les plus courants) inséré derrière une plaquette protectrice non-réfléchissante en acrylic. D'autres types d'inserts, en plastique ou en métal, sont naturellement également envisageables, de même qu'un lettrage ou une impression directement apposés sur les profilés.

Pour la finition, l'utilisateur a le choix entre des capuchons en plastique ou en aluminium. Récemment, plusieurs profilés et capuchons ont été ajoutés à la gamme afin de pouvoir réaliser des panneaux d'affichage directionnels d'une largeur de 400, 500 ou 600 mm.

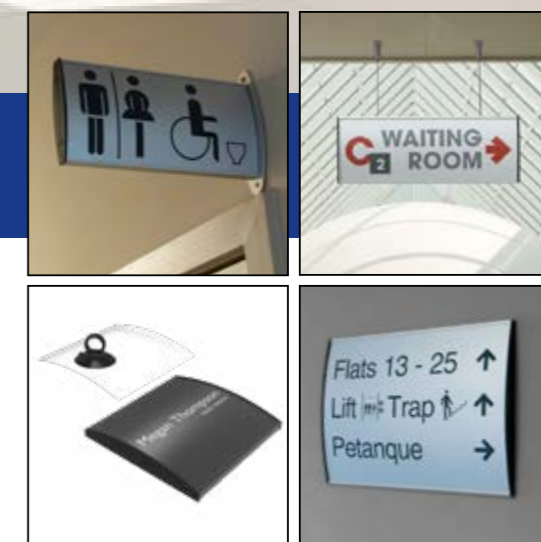

PROFILES & ACCESSORIES

CUSTOM MADE

READY MADE

## STANDARD SIZES / DIMENSIONS STANDARD

### WALL MOUNTED / FIXATION MURALE

product code	insert (hwx) in mm / insert (hxl) en mm
ST-056074-W	53 x 74 (DIN A8)
ST-056105-W	53 x 105
ST-056150-W	53 x 150 56mm
ST-056210-W	53 x 210
ST-056297-W	53 x 297
ST-078105-W	74 x 105 (DIN A7)
ST-078150-W	74 x 150
ST-078210-W	74 x 210 78mm
ST-078297-W	74 x 297
ST-078420-W	74 x 420
ST-109105-W	105 x 105
ST-109150-W	105 x 150 (DIN A6)
ST-109210-W	105 x 210 109mm
ST-109297-W	105 x 297
ST-109420-W	105 x 420
ST-150105-W	148 x 105 (DIN A6)
ST-150150-W	148 x 150
ST-150210-W	148 x 210 (DIN A5) 150mm
ST-150297-W	148 x 297
ST-150420-W	148 x 420
ST-212148-W	210 x 148 (DIN A5)
ST-212210-W	210 x 210 212mm
ST-212297-W	210 x 297
ST-212420-W	210 x 420
ST-300210-W	297 x 210 (DIN A4)
ST-300420-W	297 x 420 (DIN A3) 300mm
ST-300600-W	297 x 600

### PROJECTED FIXATION EN DRAPEAU

product code	insert (hwx) in mm / insert (hxl) en mm
ST-109148-P	105 x 148 (DIN A6)
ST-109210-P	105 x 210 109mm
ST-150150-P	148 x 150
ST-150210-P	148 x 210 (DIN A5) 150mm
ST-150297-P	148 x 297
ST-212210-P	210 x 210 212mm
ST-212297-P	210 x 297 (DIN A4)

### TABLE STAND PRÉSENTOIR DE TABLE

product code	insert (hwx) in mm / insert (hxl) en mm
ST-078105-T	74 x 105 (DIN A7) 78mm
ST-078150-T	74 x 150
ST-109075-T	105 x 74
ST-109148-T	105 x 148 (DIN A6) 109mm
ST-109210-T	105 x 210
ST-109297-T	105 x 297

NEW



product code	insert (hwx) in mm / insert (hxl) en mm
ST-056074-W-B	53 x 74 (DIN A8)
ST-056105-W-B	53 x 105
ST-056150-W-B	53 x 150 56mm
ST-056210-W-B	53 x 210
ST-056297-W-B	53 x 297
ST-078105-W-B	74 x 105 (DIN A7)
ST-078150-W-B	74 x 150
ST-078210-W-B	74 x 210 78mm
ST-078297-W-B	74 x 297
ST-078420-W-B	74 x 420
ST-109105-W-B	105 x 105
ST-109150-W-B	105 x 150 (DIN A6)
ST-109210-W-B	105 x 210 109mm
ST-109297-W-B	105 x 297
ST-109420-W-B	105 x 420
ST-150105-W-B	148 x 105 (DIN A6)
ST-150150-W-B	148 x 150
ST-150210-W-B	148 x 210 (DIN A5) 150mm
ST-150297-W-B	148 x 297
ST-150420-W-B	148 x 420
ST-212148-W-B	210 x 148 (DIN A5)
ST-212210-W-B	210 x 210 212mm
ST-212297-W-B	210 x 297
ST-212420-W-B	210 x 420
ST-300210-W-B	297 x 210 (DIN A4)
ST-300420-W-B	297 x 420 (DIN A3) 300mm
ST-300600-W-B	297 x 600

NEW



product code	insert (hwx) in mm / insert (hxl) en mm
ST-109148-P-B	105 x 148 (DIN A6)
ST-109210-P-B	105 x 210 109mm
ST-150150-P-B	148 x 150
ST-150210-P-B	148 x 210 (DIN A5) 150mm
ST-150297-P-B	148 x 297
ST-212210-P-B	210 x 210 212mm
ST-212297-P-B	210 x 297 (DIN A4)

NEW



product code	insert (hwx) in mm / insert (hxl) en mm
ST-078105-T-B	74 x 105 (DIN A7) 78mm
ST-078150-T-B	74 x 150
ST-109075-T-B	105 x 74
ST-109148-T-B	105 x 148 (DIN A6) 109mm
ST-109210-T-B	105 x 210
ST-109297-T-B	105 x 297

## STANDARD SIZES / DIMENSIONS STANDARD

### SUSPENDED SYSTÈME DE SUSPENSION

product code	insert (hwx) in mm / insert (hxl) en mm
ST-109210-S	105 x 210
ST-109297-S	105 x 297 109mm
ST-109420-S	105 x 420
ST-109600-S	105 x 600
ST-150297-S	148 x 297
ST-150420-S	148 x 420 150mm
ST-150600-S	148 x 600
ST-150840-S	148 x 840
ST-212297-S	210 x 297
ST-212420-S	210 x 420 212mm
ST-212600-S	210 x 600
ST-212840-S	210 x 840

### SUSPENDED MULTI-LEVEL SYSTÈME DE SUSPENSION MULTI-LEVEL

product code	insert (hwx) in mm / insert (hxl) en mm
ST-109210-SD	105 x 210
ST-109297-SD	105 x 297 109mm
ST-109420-SD	105 x 420
ST-109600-SD	105 x 600
ST-150297-SD	148 x 297
ST-150420-SD	148 x 420 150mm
ST-150600-SD	148 x 600
ST-150840-SD	148 x 840
ST-212297-SD	210 x 297
ST-212420-SD	210 x 420 212mm
ST-212600-SD	210 x 600
ST-212840-SD	210 x 840
STRATOCON-2	Connectors / Connecteurs (2pcs)
STRATOCON-4	Connectors / Connecteurs (4pcs)

NEW



product code	insert (hwx) in mm / insert (hxl) en mm
ST-109210-S-B	105 x 210
ST-109297-S-B	105 x 297 109mm
ST-109420-S-B	105 x 420
ST-109600-S-B	105 x 600
ST-150297-S-B	148 x 297
ST-150420-S-B	148 x 420 150mm
ST-150600-S-B	148 x 600
ST-150840-S-B	148 x 840
ST-212297-S-B	210 x 297
ST-212420-S-B	210 x 420 212mm
ST-212600-S-B	210 x 600
ST-212840-S-B	210 x 840

NEW



product code	insert (hwx) in mm / insert (hxl) en mm
ST-109210-SD-B	105 x 210
ST-109297-SD-B	105 x 297 109mm
ST-109420-SD-B	105 x 420
ST-109600-SD-B	105 x 600
ST-150297-SD-B	148 x 297
ST-150420-SD-B	148 x 420 150mm
ST-150600-SD-B	148 x 600
ST-150840-SD-B	148 x 840
ST-212297-SD-B	210 x 297
ST-212420-SD-B	210 x 420 212mm
ST-212600-SD-B	210 x 600
ST-212840-SD-B	210 x 840
STRATOCON-2-B	Connectors / Connecteurs (2pcs)
STRATOCON-4-B	Connectors / Connecteurs (4pcs)

Example suspended system / Exemple de système de suspension 150 x 600mm, 2 levels / 2 niveaux: ST-150600-S + STRATOCON-2 + ST-150600-SD



ALUMINIUM PROFILES  
PROFILÉS ALUMINIUM

product code	profile	insert (hwxw) / insert (lxh)	
STRATO 2 0A8	56mm	DIN A8 (53mm)	5m/l
STRATO 2 0A7	78mm	DIN A7 (74mm)	5m/l
STRATO 2 0A6	109mm	DIN A6 (105mm)	5m/l
STRATO 2 0A5	150mm	DIN A5 (148mm)	5m/l
STRATO 2 0A4	212mm	DIN A4 (210mm)	5m/l
2. silver anodised / anodisé naturel 5. black anodised / noir anodisé			
	DIN A3 (297mm)		5m/l
STRATO 2 0A3S	edge profile / profilé latéral		5m/l
STRATO 2 0A3M	mid profile / section médiane		5m/l
2. silver anodised / anodisé naturel 5. black anodised / noir anodisé			
STRATOBS10	all sizes / toutes les tailles	universal edge profile / profilé latéral universel	5m/l
1. mill finish / brut 2. silver anodised / anodisé naturel			

PLASTIC ENDCAPS  
CAPUCHONS PLASTIQUES

product code	description
STRATOCAP3A8	A8, black / noir
STRATOCAP3A7	A7, black / noir
STRATOCAP3A6	A6, black / noir
STRATOCAP3A5	A5, black / noir
STRATOCAP3A4	A4, black / noir
STRATOCAP3A3	A3, black / noir
2. grey / gris 3. black / noir	

ALUMINIUM ENDCAPS  
CAPUCHONS ALUMINIUM

product code	description
STRALUCAPA8	A8 single-sided / simple face
STRALUCAPA8D	A8 double-sided / double face
STRALUCAPA7	A7 single-sided / simple face
STRALUCAPA7D	A7 double-sided / double face
STRALUCAPA6	A6 single-sided / simple face
STRALUCAPA6D	A6 double-sided / double face
STRALUCAPA5	A5 single-sided / simple face
STRALUCAPA5D	A5 double-sided / double face
STRALUCAPA4	A4 single-sided / simple face
STRALUCAPA4D	A4 double-sided / double face
STRALUCAPA3	A3 single-sided / simple face
STRALUCAPA3D	A3 double-sided / double face
STRALUCAP400	400mm single-sided / simple face
STRALUCAP500	500mm single-sided / simple face
STRALUCAP600	600mm single-sided / simple face

DIRECTORY / PANNEAU D’AFFICHAGE



Directory example / Exemple de panneau d’affichage 400x600mm: 2x STRATO20A3S + 2x STRALUCAP400

TABLE STAND / PRÉSENTOIR DE TABLE

product code	description
STRATOTS3A7	A7 black / noir
STRATOTS3A6	A6 black / noir
STRATOTS3UNI	universal black / universel noir
2. grey / gris 3. black / noir	

PROJECTING BRACKET  
SUPPORT DE MONTAGE EN DRAPEAU

product code	description
STRATOBRACA6	A6 anodised / anodisé
STRATOBRACA5	A5 anodised / anodisé
STRATOBRACA4	A4 anodised / anodisé

ANTI-REFLEX PET STRIPS  
FEUILLES ANTI-REFLET PET

product code	description
STRATOSTRIPA8	1250 x 52,5 x 0,6mm
STRATOSTRIPA7	1250 x 74 x 0,6mm
STRATOSTRIPA6	1250 x 106 x 0,6mm
STRATOSTRIPA5	1250 x 147,5 x 0,6mm
STRATOSTRIPA4	1250 x 209,5 x 1mm
STRATOSTRIPA3	1250 x 297 x 1mm

ALUMINIUM SLIDER PROFILE /  
PROFILÉ GLISSIÈRES EN ALUMINIUM

product code	description
SLIDERRCS	slider profile. 2,5m profilé glissières. 2,5m

SCREWS / VIS

product code	description
SCREW003	2. grey / gris 3. black / noir

HANGING CLIP / CLIP DE SUSPENSION

product code	description
APC3000S	

CONNECTOR / CLIP DE CONNEXION

product code	description
STRATOCON3	

HANGING KIT / KIT DE SUSPENSION

product code	description
APC4101	2x conical clip + 1,5m wire 2x clip conique + 1,5m fil

See also page 52 for more suspension systems.  
Pour plus d’infos sur les systèmes de suspension,  
voyez également sur la page 52.

WALL MOUNTED  
FIXATION MURALE

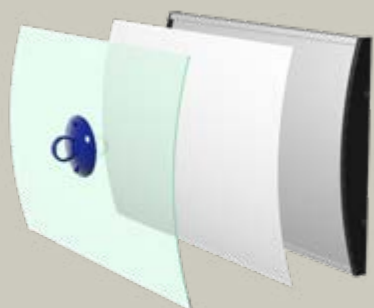

SUSPENDED  
SYSTÈME DE SUSPENSION

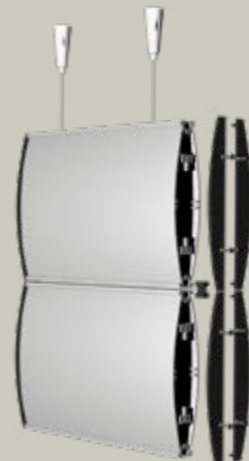

PROJECTED  
FIXATION EN DRAPEAU

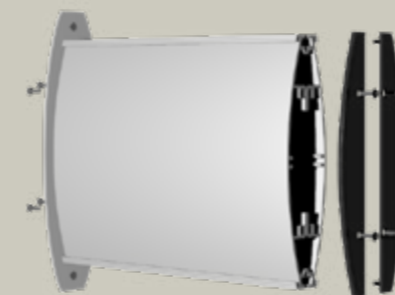

TABLE STAND  
PRÉSENTOIR DE TABLE



# CURVO PLUS



[www.cosign.be/curvoplus](http://www.cosign.be/curvoplus)

Curvo Plus is a modern, indoor sign system made from high-quality aluminium and executed in a stylish design with gently curved profiles and rounded corners.

The tabs with a stainless steel look keep the signs and the anti-reflective covers in place and give the signs extra cachet.

Moreover, the tabs are the same for all profiles. This limits the number of components and simplifies installation. It is possible to inscribe or print directly on the profiles.

CURVO PLUS est un système d'enseigne d'intérieur qui combine flexibilité, simplicité et élégance, fabriqués à partir d'un aluminium de qualité supérieure et réalisés avec un design stylé avec des profils légèrement galbés et des angles arrondis.

Les clous d'apparence inox maintiennent en place les porteurs de données et les plaquettes de couverture anti-reflet, mais en plus elles donnent un cachet supplémentaire à votre signalétique.

De plus, les trous conviennent pour tous les profils, ce qui réduit le nombre des différents éléments et facilite l'installation. Il est également possible d'appliquer le lettrage ou d'imprimer directement sur les profilés.

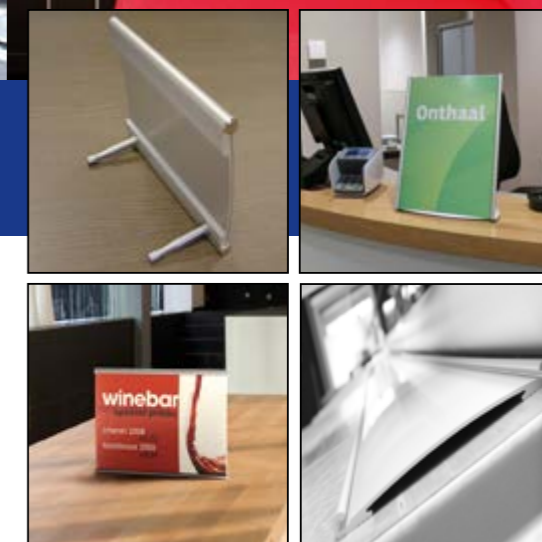

PROFILES & ACCESSORIES

CUSTOM MADE

READY MADE

## STANDARD SIZES / DIMENSIONS STANDARD

### WALL MOUNTED FIXATION MURALE



product code	insert (wxh) in mm / insert (lxh) en mm	
CV-104150-W	89 x 150	104mm
CV-104210-W	89 x 210	
CV-104297-W	89 x 297	
CV-104420-W	89 x 420	
CV-134150-W	119 x 150	134mm
CV-134210-W	119 x 210	
CV-134297-W	119 x 297	
CV-134420-W	119 x 420	
CV-164105-W	149 x 105 (DIN A6)	164mm
CV-164150-W	149 x 150	
CV-164210-W	149 x 210 (DIN A5)	
CV-164297-W	149 x 297	
CV-164420-W	149 x 420	
CV-224150-W	210 x 150	224mm
CV-224297-W	210 x 297 (DIN A4)	
CV-312210-W	297 x 210 (DIN A4)	312mm
CV-312420-W	297 x 420 (DIN A3)	

### PROJECTED FIXATION EN DRAPEAU



product code	insert (wxh) in mm / insert (lxh) en mm	
CV-104090-P	89 x 90	104mm
CV-134120-P	119 x 120	134mm
CV-134240-P	119 x 240	
CV-164150-P	149 x 150	164mm
CV-164297-P	149 x 297	
CV-224210-P	210 x 210	224mm

### SUSPENDED SYSTÈME DE SUSPENSION



product code	insert (wxh) in mm / insert (lxh) en mm	
CV-104420-S	89 x 420	104mm
CV-104600-S	89 x 600	
CV-134420-S	119 x 420	134mm
CV-134600-S	119 x 600	
CV-164150-S	149 x 150	164mm
CV-164297-S	149 x 297	
CV-164600-S	149 x 600	
CV-164840-S	149 x 840	
CV-224297-S	210 x 297	
CV-224600-S	210 x 600	224mm
CV-224840-S	210 x 840	

### TABLE STAND PRÉSENTOIR DE TABLE



product code	insert (wxh) / insert (lxh) en mm	
CV-164074-T	149 x 74	164mm
CV-164105-T	149 x 105 (DIN A6)	
CV-224074-T	210 x 74	224mm
CV-224105-T	210 x 105	

### SUCTION CUP VENTOUSE



product code
VACUUMC2

## PROFILES & ACCESSORIES / PROFILÉS & ACCESSOIRES

### ALUMINIUM PROFILES PROFILÉS ALUMINIUM

	product code	profile	insert (wxh) / insert (lxh) en mm	
	CURVO 2 090	104mm	89mm	5m/l
	CURVO 2 120	134mm	119mm	5m/l
	CURVO 2 150	164mm	149mm	5m/l
	CURVO 2 210	224mm	210mm (DIN A4)	5m/l
	CURVO 2 297	312mm	297mm (DIN A3)	5m/l
	CURVO BS20	universal side profile profilé latéral universel		5m/l

### TABS / CLOUS

	product code	description
	TAB001	inox-look / clous d'apparence inox
	TAB002	baseplate / plaque de base + 2x TAB002

### ALUMINIUM ENDCAPS CAPUCHONS ALUMINIUM

	product code	description
	CURCAP90	90mm double-sided / double face
	CURCAP120	120mm double-sided / double face
	CURCAP150	150mm double-sided / double face
	CURCAP210	210mm double-sided / double face

### INOX STANDARD PRÉSENTOIR DE TABLE EN INOX

	product code
	CURVOTS

### PROJECTING BRACKET SUPPORT DE MONTAGE EN DRAPEAU



product code	description
CURBRAC90	support / support: 90mm
CURBRAC120	support / support: 120mm
CURBRAC150	support / support: 150mm
CURBRAC210	support / support: 210mm

### HANGING KIT / KIT DE SUSPENSION



product code	description
APC4101	2x conical clip + 1,5m wire 2x clip conique + 1,5m fil

See also page 52 for more suspension systems.  
Pour plus d'infos sur les systèmes de suspension,  
voyez également sur la page 52.

### ANTI-REFLEX PET STRIPS FEUILLES ANTI-RÉFLET PET



product code	description
STRIP89	1250 x 89 x 0,6mm
STRIP119	1250 x 119 x 0,6mm
STRIP149	1250 x 149 x 1mm
STRIP209	2050 x 209 x 2mm
STRIP297	2050 x 297 x 2mm

## WALL MOUNTED FIXATION MURALE



## SUSPENDED SYSTÈME DE SUSPENSION



## PROJECTED FIXATION EN DRAPEAU



## TABLE STAND PRÉSENTOIR DE TABLE



# MODULE PLUS INDOOR



[www.cosign.be/moduleplusindoor](http://www.cosign.be/moduleplusindoor)

## A CLASSIC PRODUCT THAT CONTINUES TO DO THE JOB PERFECTLY!

With the Module Plus Indoor, Cosign developed a modular sign system at the beginning of the 1990s that started a new trend within architectural signage and served as an inspiration for many of our colleagues.

The Module Plus Indoor consists of a series of flat aluminium profiles in different widths that has a 15.5 mm and 31 mm module as the basic profiles. The profiles can be "clicked" into place in an easy manner on plastic end caps or clips to create door signs, pictograms, directories, etc. Single-sided signs for wall mounting and double-sided systems for hanging or flag mounting are possible.

The Module Plus Indoor platform does not just offer the sign maker a simple, versatile and flexible standard solution, it also offers space to the creative sign maker to place his or her own emphasis and to develop customised products.



## UN GRAND CLASSIQUE QUI DONNE ENCORE TOUJOURS ENTIÈRE SATISFACTION !

Au début des années '90, Cosign a mis au point le Module Plus Indoor pour développer un nouveau système d'enseigne modulaire. Celui-ci a créé une nouvelle tendance dans le secteur de la signalisation architecturale et a servi de source d'inspiration pour de nombreux collègues.

Le Module Plus Indoor se compose d'une série de profilés plats en aluminium de différentes largeurs, avec le modules de 15,5mm et 31 mm faisant figure de profilé de base. Les profilés s'emboîtent très facilement sur des embouts ou des clips en plastique de façon à créer des enseignes de porte, des pictogrammes, des panneaux d'affichage, etc. Le système permet de créer des panneaux simple face à apposer sur un mur, de même que des systèmes double face à suspendre au plafond ou à fixer en drapeau au mur.

La plate-forme Module Plus Indoor offre aux fabricants d'enseignes non seulement une solution standard flexible, simple et polyvalente, mais donne également au designer la possibilité d'ajouter sa touche créative personnelle et de développer des produits fabriqués sur mesure.

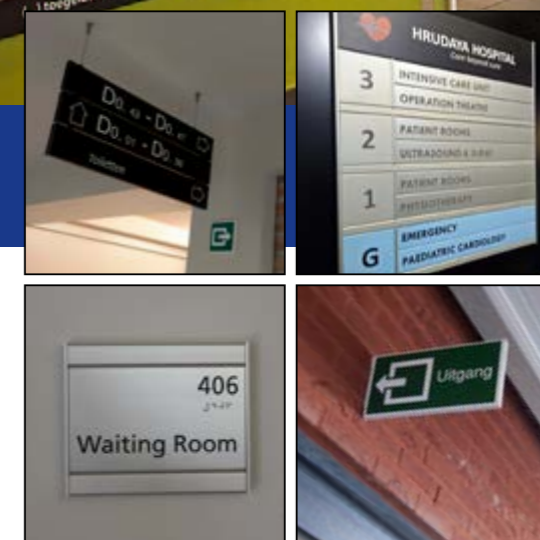

ALUMINIUM TEXT PROFILES  
PROFILÉS ALUMINIUM

product code	description
ANO 1 300	300 mm mill finish / brut 5m/l
ANO 1 250	250 mm mill finish / brut 5m/l
ANO 1 187	187 mm mill finish / brut 5m/l
ANO 1 156	156 mm mill finish / brut 5m/l
ANO 1 125	125 mm mill finish / brut 5m/l
ANO 1 093	93 mm mill finish / brut 5m/l
ANO 1 062	62 mm mill finish / brut 5m/l
ANO 1 046	46,5 mm mill finish / brut 5m/l
ANO 1 031	31 mm mill finish / brut 5m/l
ANO 1 015	15,5 mm mill finish / brut 5m/l

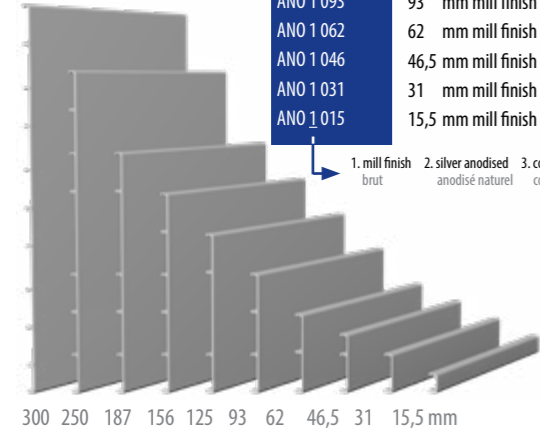

1. mill finish brut 2. silver anodised anodisé naturel 3. color colour 4. gold anodised anodisé d'or

ALUMINIUM SLIDER PROFILE  
PROFILÉS GLISSIÈRES EN ALUMINIUM

product code	profile profilé	insert insert	thickness épaisseur
ASO 1 093	93 mm	89,5 mm	≤1,6 mm
ASO 1 062	62 mm	58 mm	≤1,6 mm
ASO 1 046	46,5 mm	42,5 mm	≤1,2 mm
ASO 1 031	31 mm	27 mm	≤1,0 mm
ASO 1 015	15,5 mm	11,5 mm	≤1,0 mm

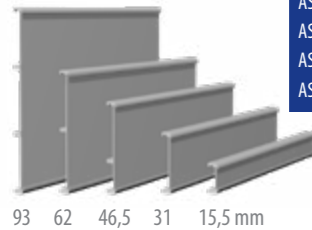

1. mill finish brut 2. silver anodised anodisé naturel 3. color colour 4. gold anodised anodisé d'or

ASO 1 031.SP	31 mm	custom	≤1,2 mm
--------------	-------	--------	---------

1. mill finish brut 2. silver anodised anodisé naturel 3. color colour 4. gold anodised anodisé d'or

SINGLE SIDED ENDCAPS  
CLIPS SIMPLE FACE

product code	description
APE 3 250	250 mm black / noir
APE 3 218	218 mm black / noir
APE 3 187	187 mm black / noir
APE 3 156	156 mm black / noir
APE 3 125	125 mm black / noir
APE 3 093	93 mm black / noir
APE 3 062	62 mm black / noir
APE 3 046	46,5 mm black / noir
APE 3 031	31 mm black / noir
APE 3 015	15,5 mm black / noir

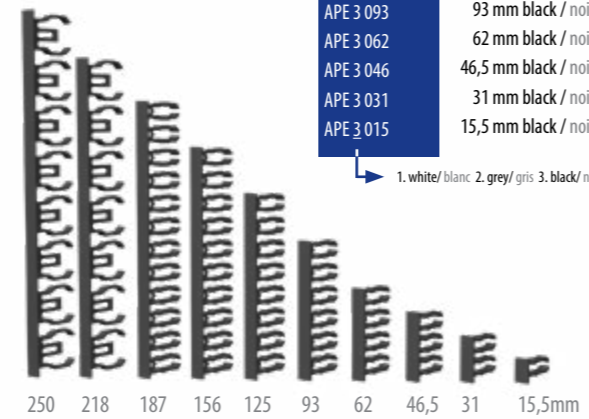

1. white/blanc 2. grey/gris 3. black/noir

DOUBLE SIDED ENDCAPS  
CLIPS DOUBLE FACE

product code	description
APD 3 300	300 mm black / noir
APD 3 250	250 mm black / noir
APD 3 187	187 mm black / noir
APD 3 156	156 mm black / noir
APD 3 125	125 mm black / noir
APD 3 093	93 mm black / noir
APD 3 062	62 mm black / noir

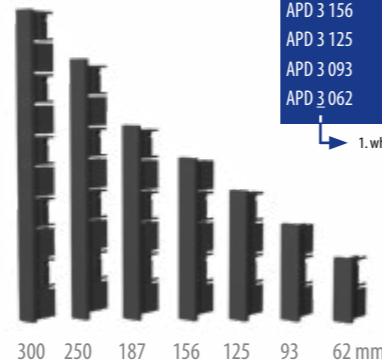

1. white/blanc 2. grey/gris 3. black/noir

HANGING KIT / KIT DE SUSPENSION



product code	description
APC4101	2x conical clip + 1,5m wire 2x clip conique + 1,5m fil

See also page 52 for more suspension systems.  
Pour plus d'infos sur les systèmes de suspension, voyez également sur la page 52.



product code	description
APC 3 000	plastic suspension clip / clip suspension plastique 2. grey/gris 3. black/noir



product code	description
APC 4 400	metal suspension profilé / profil de jonction (5m)
APC 4 500	metal suspension clip / clip suspension metal (30mm)



product code	description
APC 6 000	wedge ABS black / cale ABS noir

SUCTION CUP / VENTOUSES



product code
VACUUMC2
VACUUMC

KEY / CLÉ DE DÉMONTAGE



product code
APK1000

TABLE STAND / CHEVALET DE BUREAU



product code	description
APC7000	wedge / cale chevalet

product code	description
APW 3 031	triangular endcap / triangle chevalet 31mm 1. white/blanc 2. grey/gris 3. black/noir

product code	description
APW 3 062	triangular endcap / triangle chevalet 62mm 2. grey/gris 3. black/noir

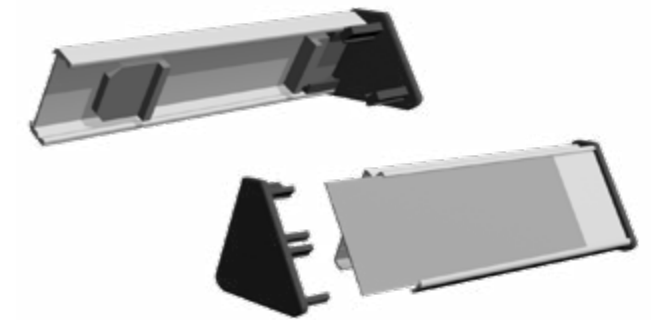

WALL MOUNTED  
FIXATION MURALE

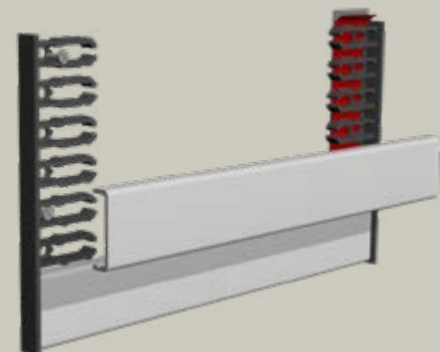

PROJECTED  
FIXATION EN DRAPEAU

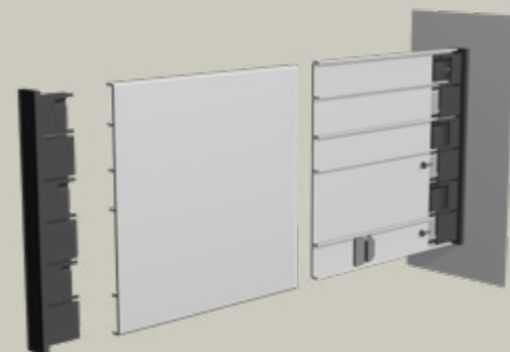

SUSPENDED  
SYSTÈME DE SUSPENSION

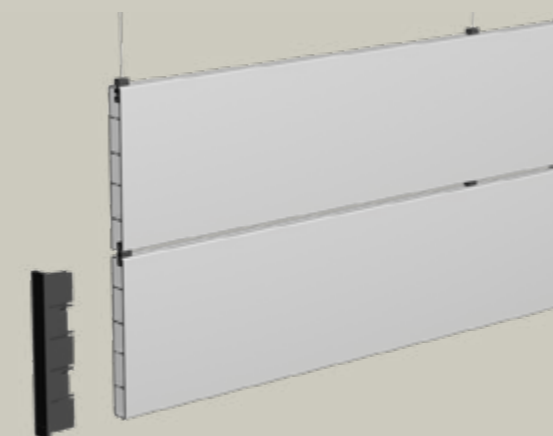
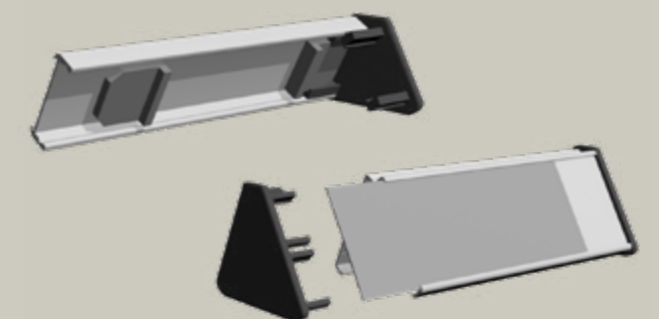
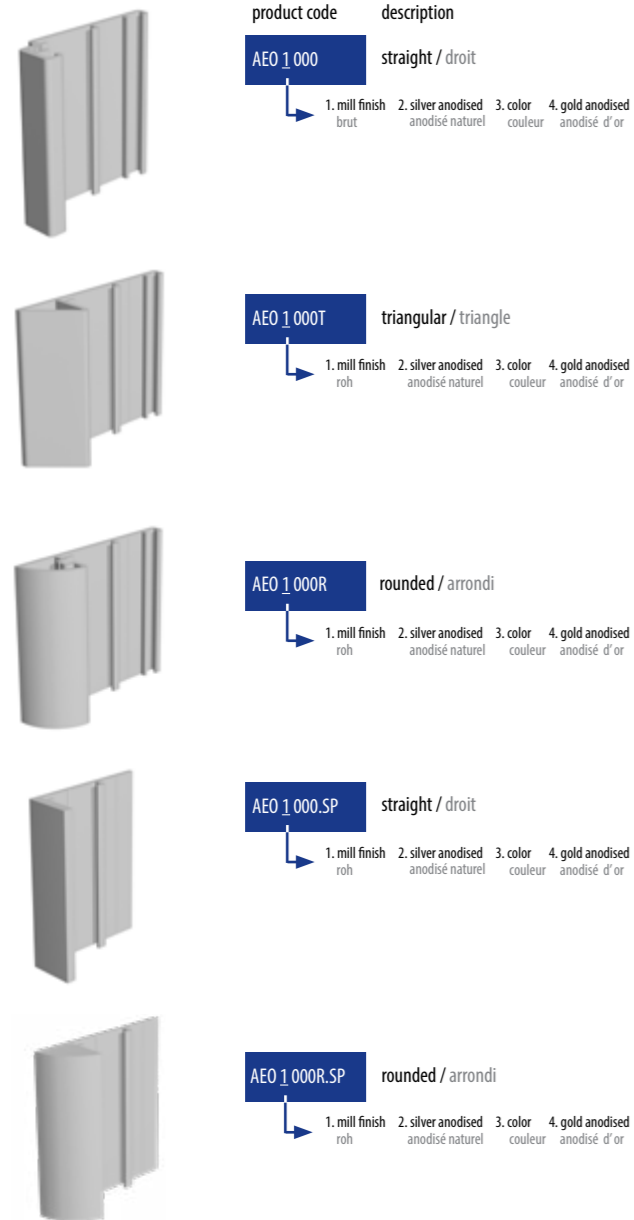

TABLE STAND  
CHEVALET DE BUREAU



## PROFILES / PROFILÉS

### ALUMINIUM SIDE PROFILES PROFILÉS LATÉRAUX EN ALUMINIUM



### SUPPORT / DIVIDER PROFILES PROFILÉ DE RENFORT / SÉPARATION

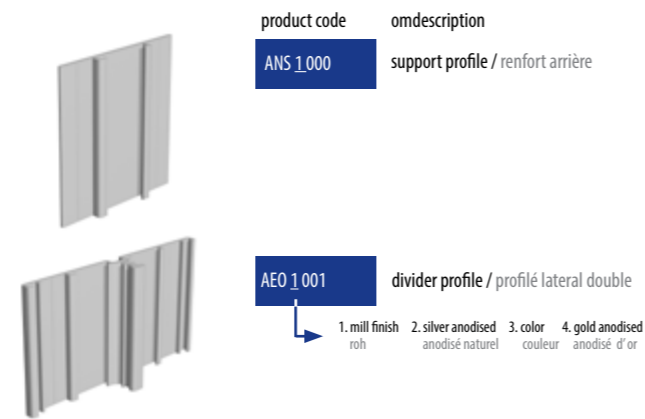

### SIDE PROFILE COMBINATION PROFILÉS ALLONGÉS

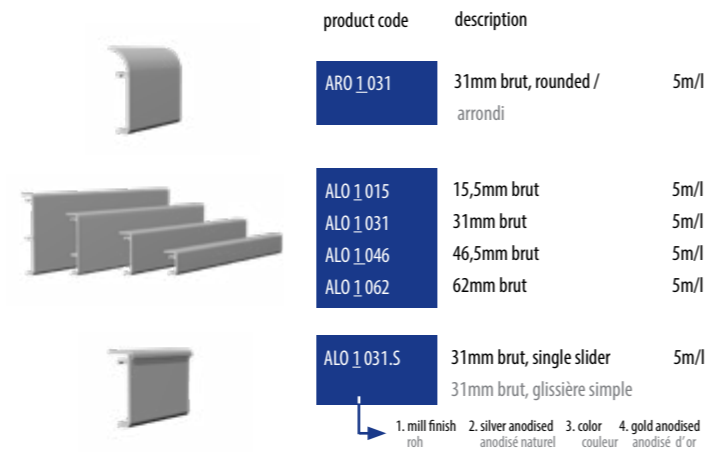

### FRAME PROFILE / PROFILÉ DE CADRE



## ACCESSORIES / ACCESSOIRES

### ENDCAPS FOR SIDE PROFILES CAPUCHONS DE FINITION POUR PROFILÉS LATÉRAUX

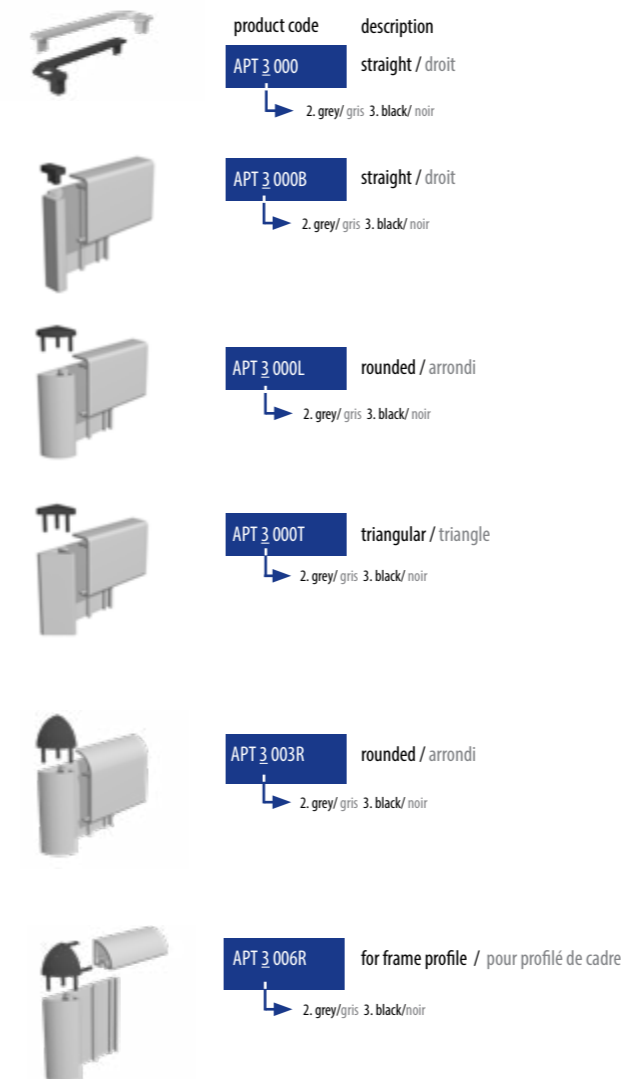

### CLIPS FOR SIDE PROFILES CLIPS POUR PROFILÉS LATÉRAUX

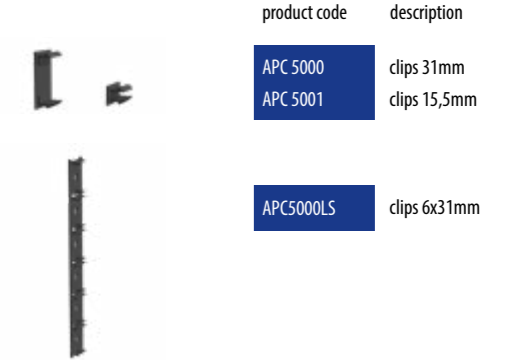

### INTERIOR TOTEM / TOTEM INTÉRIEURE

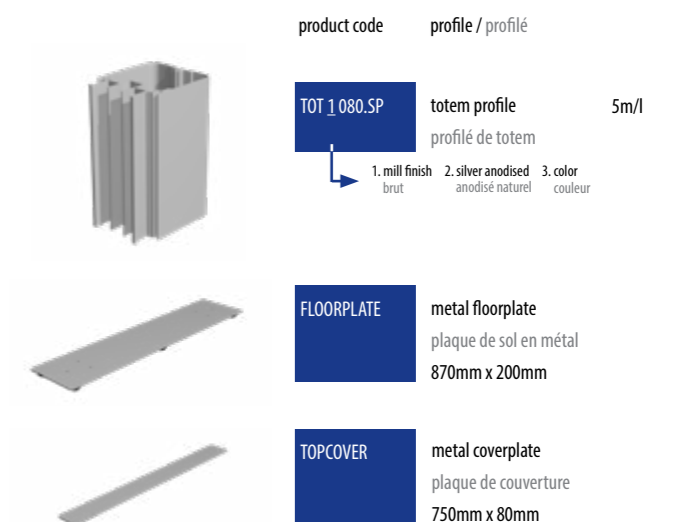

## DIRECTORY TABLEAU DIRECTIONNEL

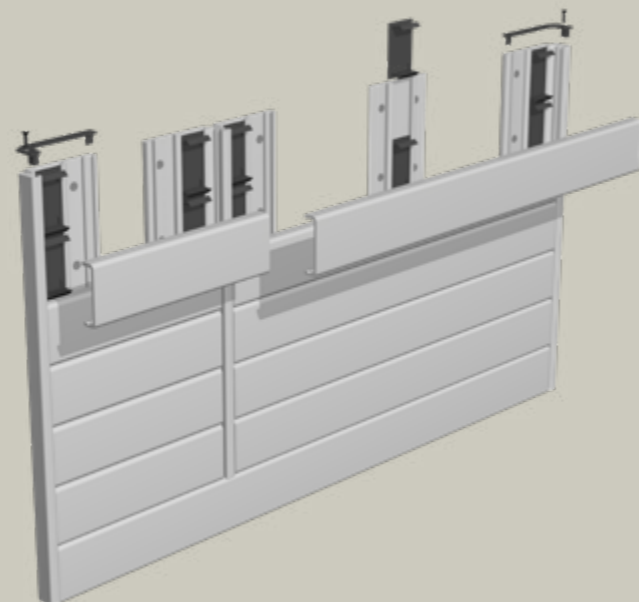

## INTERIOR TOTEM TOTEM INTÉRIEURE

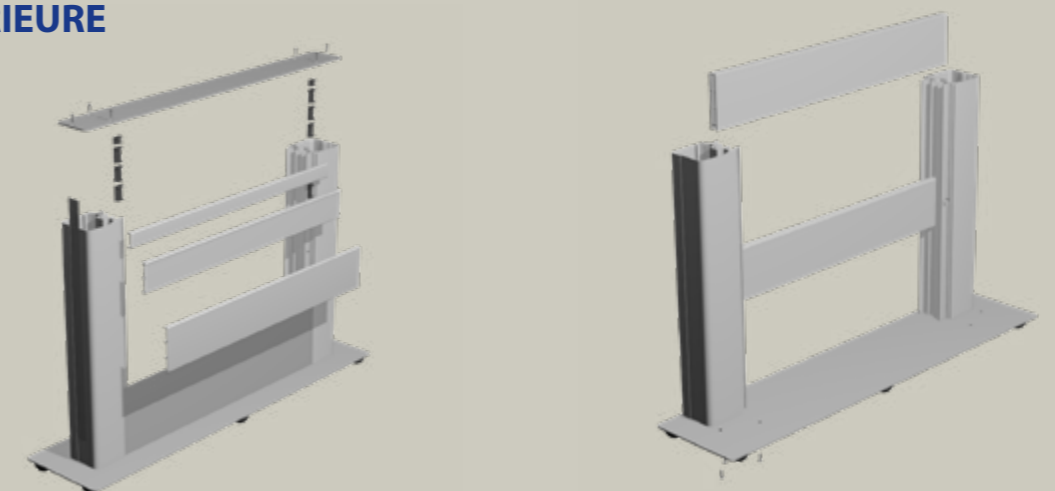

# INDOOR LIGHTBOX



[www.cosign.be/indoor-lightbox](http://www.cosign.be/indoor-lightbox)

Cosign developed an elegant indoor lightbox with a depth of only 75mm (single-sided) or 100mm (double-sided). The hinging frame on top makes maintenance and a quick change of the acrylic panels and/or graphics extremely easy.

The hinging frame comes in 2 versions. One has the typical I-Sign look with the thin edge. The other one has an edge of 12.5mm which allows for the acrylic panels to be fully illuminated.

The perfect lightbox for airports, metro stations, garages, ...

Cosign a développé un caisson lumineux élégant pour l'intérieur avec une profondeur de 75mm (simple face) ou 100mm (double face). Le cadre charnière en haut assure une maintenance facile et un changement rapide des panneaux acryliques et/ou des images.

Le cadre charnière est disponible en 2 versions. L'un a le look typique 'I-sign' avec un bord mince. L'autre a un bord de 12,5mm qui permet d'illuminer les panneaux acryliques complètement. Le caisson lumineux sera parfait pour des aéroports, des stations de métro, garages, ...



PROFILES & ACCESSORIES  
COSIGN

## ALUMINIUM PROFILES / PROFILÉS ALUMINIUM

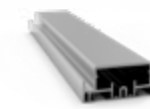

product code	description	
LB-BASE-DS10	base profile double sided profilé base double face	6,1m/l
	1. mill finish brut 2. silver anodised anodisé naturel	

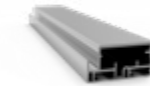

product code	description	
LB-BASE-SS10	base profile single sided profilé base simple face	6,1m/l
	1. mill finish brut 2. silver anodised anodisé naturel	



product code	description	
LB-FRAME-N10	frame profile 12,5mm silver anodised profilé de cadre 12,5mm anodisé naturel	6,1m/l



product code	description	
LB-FRAME-I10	frame profile 1,5mm silver anodised profilé de cadre 1,5mm anodisé naturel	6,1m/l



product code	description	
LB-HINGE	hinge profile mill finish profilé de charnière	6,1m/l

## ACCESSORIES / ACCESSOIRES



product code	description	
LB-BASE-CORNER	corner for base profiles pièce d'angle pour profilé base	6,1m/l



product code	description	
LB-FRAME-CORNER	corner for frame profiles pièce d'angle pour profilé de cadre	6,1m/l



### SINGLE SIDED - FRAME I SIMPLE FACE - CADRE I

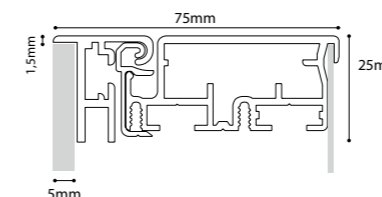

### DOUBLE SIDED - FRAME I DOUBLE FACE - CADRE I

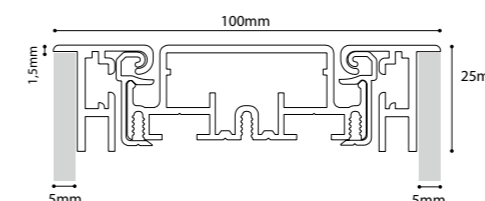

### SINGLE SIDED - FRAME N SIMPLE FACE - CADRE N

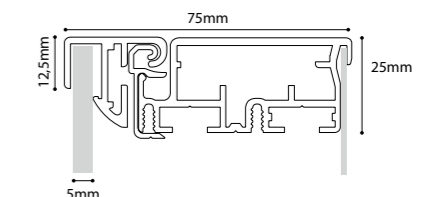

### DOUBLE SIDED - FRAME N DOUBLE FACE - CADRE N

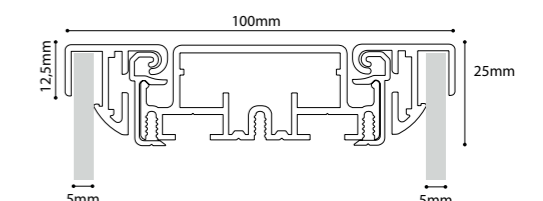

# SOLED



[www.cosign.be/soled](http://www.cosign.be/soled)

SOLED is an architectural sign application where a LED strip is integrated into the profiles that ensures the light is introduced in a glass or acrylic sheet from the side. This ensures that the image on the front of the sheet is lit up. The image can easily be added to the sheet using a film or it can be engraved into the sheet.

SOLED is a modular system where the customer can choose between a round, curved or square profile and where the signs can be wall mounted, suspended or flag mounted.

SOLED est un système d'enseignes architecturales dans lequel une bande lumineuse LED est incorporée dans les profilés de façon à projeter la lumière latéralement dans une plaque de verre ou d'acrylate, et ainsi éclairer l'image située à l'avant-plan. L'image peut être fixée très facilement à l'aide d'un film adhésif, ou être gravée sur la plaque elle-même.

Dans le système modulaire SOLED, le client a le choix entre un profilé arrondi, courbe ou rectangulaire. De plus, les enseignes peuvent être suspendues au plafond ou fixées sur un mur, soit à plat, soit perpendiculairement à celui-ci.



## ALUMINIUM PROFILES PROFILÉS ALUMINIUM

product code	profile / profilé	
SOL_1000.B	base / structure	5m/l
SOL_1000.R	round / rond	5m/l
SOL_1000.C	ellipse / elliptique	5m/l
SOL_1000.S	square / carré	5m/l

1. mill finish brut  
2. silver anodised anodisé naturel

## ALUMINIUM ENDCAPS CAPUCHONS ALUMINIUM

product code	description
SOLCAP08.R	round / rond (8mm)
SOLCAP12.R	round / rond (12mm)
SOLCAP08.C	ellipse / elliptique (8mm)
SOLCAP12.C	ellipse / elliptique (12mm)
SOLCAP08.S	square / carré (8mm)
SOLCAP12.S	square / carré (12mm)
SOLCAP08.SC	combined / combinaison (8mm)
SOLCAP12.SC	combined / combinaison (12mm)

## PROJECTING BRACKET SUPPORT DE MONTAGE EN DRAPEAU

product code	description
SOLBRAC08	for plates 8mm / pour panneaux 8mm
SOLBRAC12	for plates 12mm / pour panneaux 12mm

## HANGING CLIP / CLIP DE SUSPENSION

product code
APC3000S

## HANGING KIT / KIT DE SUSPENSION

product code	description
APC4101	2x conical clip + 1,5m wire 2x clip conique + 1,5m fil

See also page 52 for more suspension systems.  
Pour plus d'infos sur les systèmes de suspension, voyez également sur la page 52.

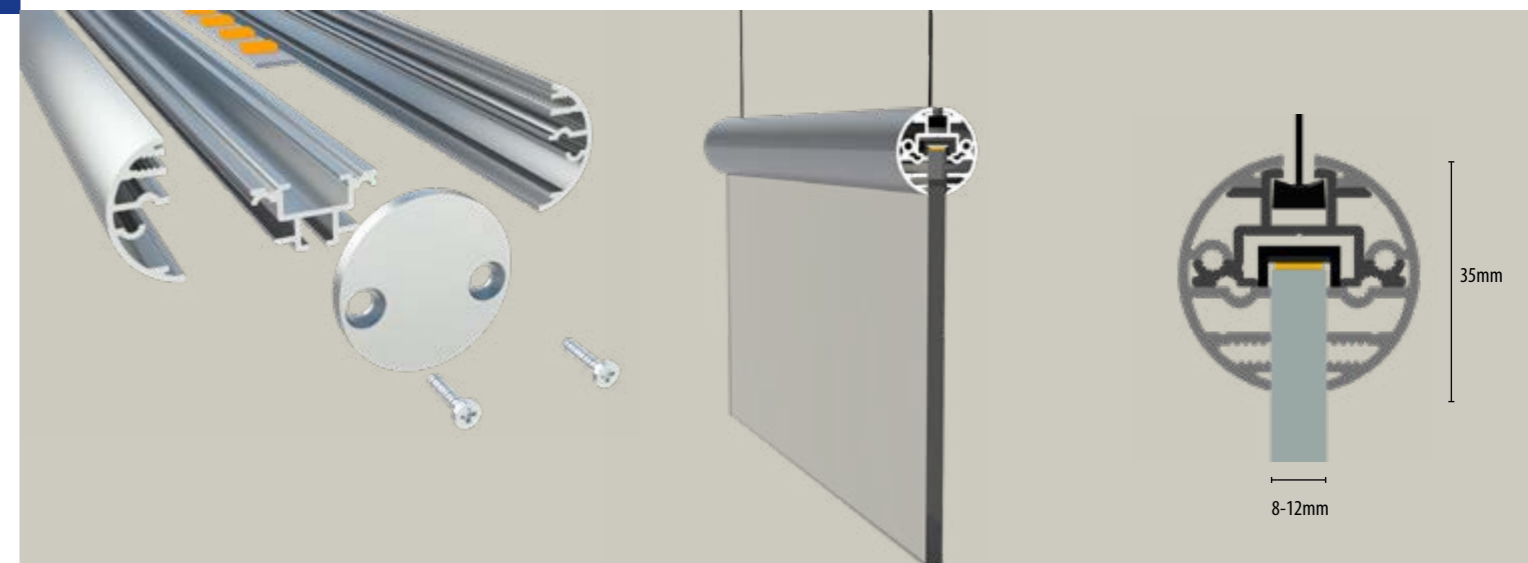

# LED LIGHT SHEETS



[www.cosign.be/ledlightsheets](http://www.cosign.be/ledlightsheets)

LED Light Sheets are thin acrylic sheets with embedded LEDs. The specific composition of the product as well as adding an optical pattern with the patented V-cut technology or a personalised dot pattern with laser technology ensures a uniform distribution of light.

LED Light Sheets can be supplied in all sizes and shapes with white LEDs in various colour temperatures or with RGB LEDs. LED Light Sheets are mainly used indoors and in display and sign projects where the available space/depth to integrate a source of light is limited.

Les LED Light Sheets sont de minces plaques acryliques à l'intérieur desquelles sont installées des lampes LED. La répartition uniforme de la lumière est assurée par la composition spécifique du produit ainsi que par l'utilisation d'un motif de quadrillage, gravé à l'aide de la technologie brevetée V-cut, ou d'un motif personnalisé de petites sphères gravé au laser.

Les LED Light Sheets sont disponibles dans toutes les formes et dimensions, et équipés de LED RVB ou de LED blanches de diverses températures de couleur. Les LED Light Sheets sont principalement utilisés dans des projets d'affiches ou d'enseignes d'intérieur pour lesquels l'espace ou la profondeur disponibles pour installer la source lumineuse sont limités.

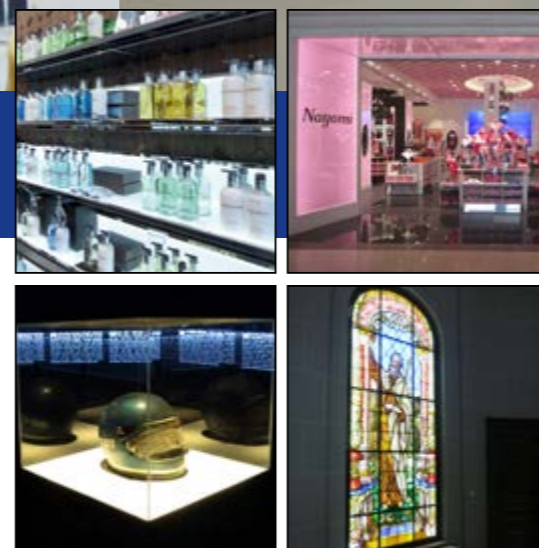

**LED LIGHT SHEET**  
by Cosign

CUSTOM  
MADE  
COSIGN

Material Matériau	Acrylic / Acrylate (PMMA)
Thickness Épaisseur	6mm, 8mm, 10mm (RGB Leds / LED RVB)
Pattern Motif	V-cut optical pattern / Motif de quadrillage V-cut (1,4mm - 2,8mm - 5,6mm)  Laser dot pattern (personalised) Motif de sphères gravé au laser (personnalisé)
Max. size Dimensions maximales	3000mm x 1500mm
LED	5630 SMD LED (0,25W P=15mm)
Input voltage Tension d'alimentation	AC 100 - 240V 50/60Hz
Operating voltage Tension de service	DC 12V - 24V
Efficiency Rendement	120lm / W
Colour temperature Température de couleur	3000K, 3700K, 4100K, 5300K, 6000K, 6500K, RGB
CRI Indice de rendu de couleur	65 - 90
Degree of protection Classe de protection	IP54 - IP67
Service life Durée de vie	>50.000 uur (L <sub>70</sub> )
Guarantee Garantie	LED Light Sheets (3 years / 3 ans) - acrylic / Acrylate (5 years / 5 ans)
Operating temperature Température de service	-30°C tot +40°C -30°C à +40°C
Accessories Accessoires	Power supplies, connectors, splitters, RGB drivers, dimmers. Sources d'alimentation, connecteurs, répartiteurs, contrôleurs de RVB, gradateurs.

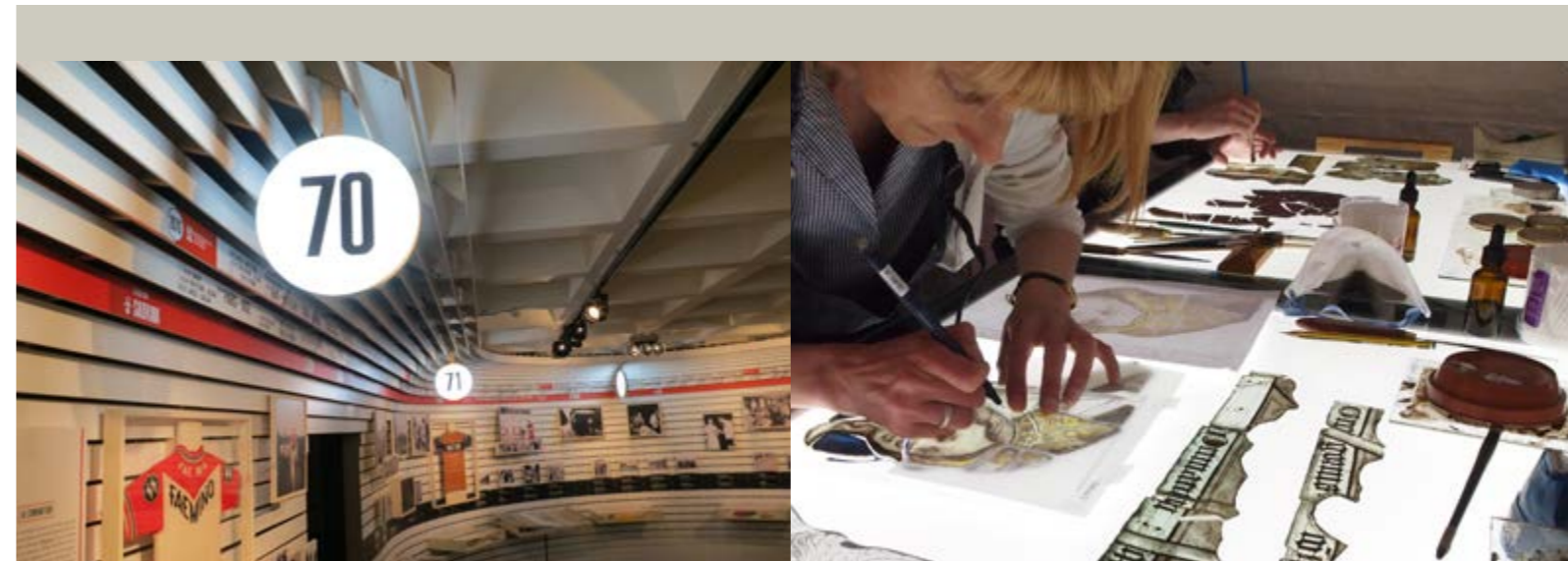

# TEXTILE FRAME



[www.cosign.be/textileframe](http://www.cosign.be/textileframe)

## COSIGN TEXTILE FRAMES: INFINITE POSSIBILITIES

Textile frames are the solution for the fast and easy exchange of printed textile fabrics. The image is printed on a textile fabric and a silicon beading is added around it. This is simply pressed into the profile that ensures that the slightly stretchable fabric can be stretched perfectly.

The convenience of use of our aluminium profiles in combination with innovative accessories and high-quality textile fabrics that can be printed up to 3 m wide seamlessly means that our textile frames are perfectly suitable for dressing and setting up shops, showrooms, offices and fair stands. Regardless of whether you want a wall frame or a standalone or hanging frame, you will find the right solution with our single- and double-sided textile profiles.

Cosign also offers LED profiles in which you can integrate High Power LED modules that will ensure that the fabric is lit up uniformly and the image is done even better justice. You can also include a noise-dampening material behind the printed fabric to improve the acoustics of a room or to create partitions. You will not just find the profiles and accessories at Cosign, you can also order the full custom-made product including the printed fabric.



## LES CADRES TEXTILE DE COSIGN : DES POSSIBILITÉS INFINIES

Les cadres tissu tendu sont la solution idéale pour pouvoir remplacer rapidement et facilement les tissus imprimés. L'image est imprimée sur un tissu, et tout le périmètre de ce dernier est muni d'une bande en silicone. La bande s'insère facilement dans le profilé de façon à tendre parfaitement le tissu légèrement extensible.





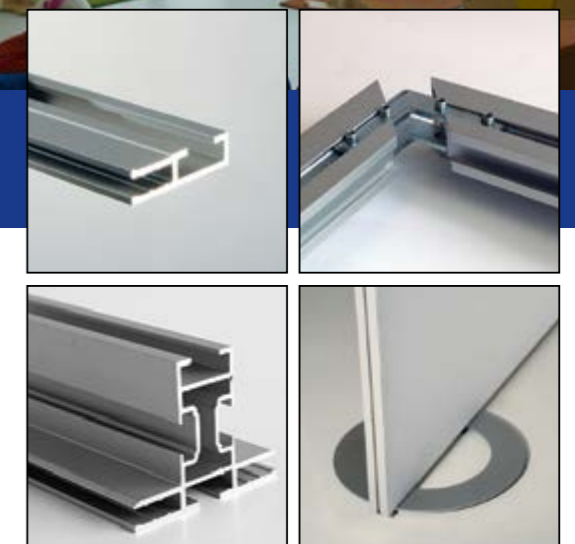

La facilité avec laquelle nos profilés en aluminium peuvent être combinés à des accessoires innovants et à des tissus de haute qualité, susceptibles d'être imprimés sans jointure sur une largeur atteignant 3 m, fait de nos cadres tissu tendu la solution idéale pour l'habillement et l'aménagement de magasins, showrooms, bureaux et stands de foires. Que vous recherchiez une enseigne à fixer au mur, à suspendre ou à poser librement, vous trouverez certainement une solution adaptée dans notre collection de profilés pour tissu tendu simple face ou double face.

Cosign propose également des profilés LED dans lesquels peuvent s'intégrer des modules LED High Power de façon à éclairer uniformément le tissu et à mettre encore plus en valeur l'illustration. Il est également possible d'ajouter un matériau insonorisant derrière le tissu afin d'améliorer l'acoustique d'un local ou de créer des cloisons.

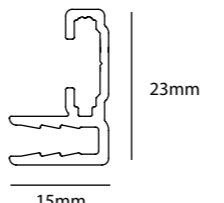

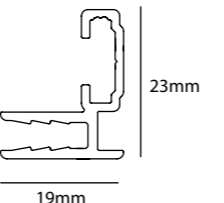
## NON ILLUMINATED PROFILES / NON ILLUMINATED PROFILÉS

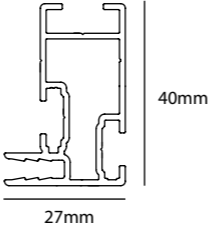
### SINGLE-SIDED TEXTILE FRAME PROFILES / PROFILÉS POUR CADRES TEXTILE SIMPLE FACE

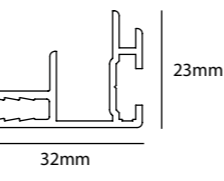
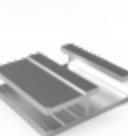
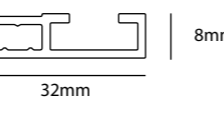





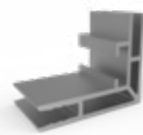
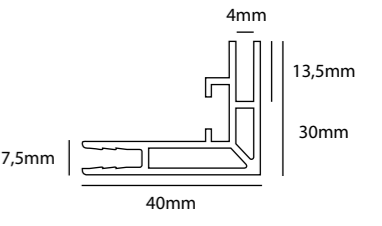

	product code	profile / profilé		
	TEXSSLD15	15x23mm (light duty)	6,1mtr	
	TEXSSLD19	19x23mm (light duty)	6,1mtr	
<b>NEW</b> 	TEXSSLD19-B	19x23mm (light duty) - Black	6,1mtr	
	TEXSSH27	27x40mm (heavy duty)	6,1mtr	
<b>NEW</b> 	TEXSSH27-B	27x40mm (heavy duty) - Black	6,1mtr	
	TEXLLS32	32x23mm (Led Light Sheet)	6,1mtr	
	TEXNICHE	32x8mm (niche)	3mtr	

### DOUBLE-SIDED TEXTILE FRAME PROFILES / PROFILÉS POUR CADRES TEXTILE DOUBLE FACE

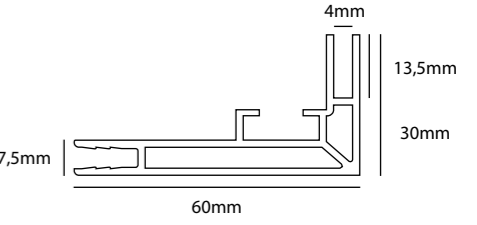
	product code	profile / profilé		
	TEXDSD44	44x40mm (heavy duty)	6,1mtr	
<b>NEW</b> 	TEXDSD44-B	44x40mm (heavy duty) - Black	6,1mtr	
	TEXDSL45	45x15mm	3mtr	

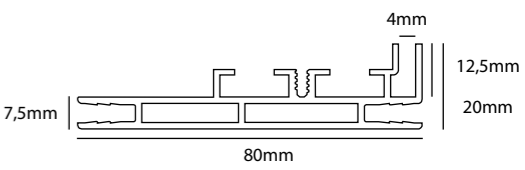
## LED PROFILES / PROFILÉS À ÉCLAIRAGE LED

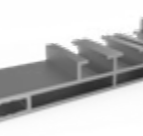
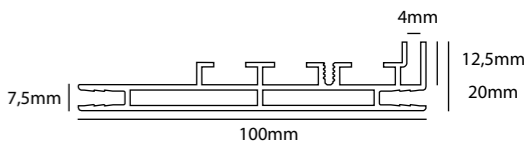
### SINGLE-SIDED TEXTILE FRAMES PROFILES / PROFILÉS POUR CADRES TEXTILE SIMPLE FACE

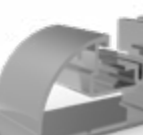
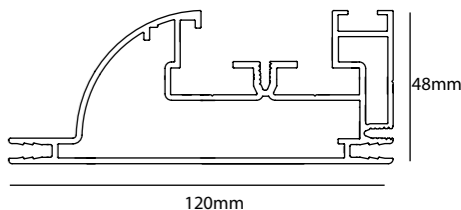
	product code	profile / profilé		
	TEXLEDSS40	40x30mm	6,1mtr	
	TEXLEDSS40-B	40x30mm - Black	6,1mtr	
	TEXLEDSS60	60x30mm	6,1mtr	
	TEXLEDSS60-B	60x30mm - Black	6,1mtr	
	TEXLEDSS80	80x20mm	6,1mtr	
	TEXLEDSS80-B	80x20mm - Black	6,1mtr	
	TEXLEDSS100	100x20mm	6,1mtr	
	TEXLEDSS100-B	100x20mm - Black	6,1mtr	
	TEXLEDSS-EL	120x48mm	6,1mtr	

## LED PROFILES / PROFILÉS À ÉCLAIRAGE LED

### DOUBLE-SIDED TEXTILE FRAMES PROFILES / PROFILÉS POUR CADRES TEXTILE DOUBLE FACE

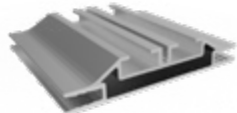
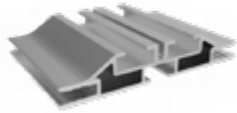
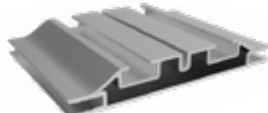
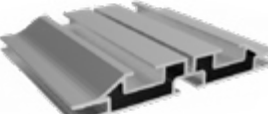
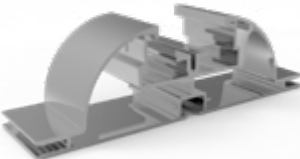
product code	profile / profilé	product code	profile / profilé
	<b>TEXLED80</b> 80x14,5mm 6,1mtr		<b>TEXLED80T</b> 80x14,5mm 6,1mtr
	<b>TEXLED100</b> 100x14,5mm 6,1mtr		<b>TEXLED100T</b> 100x14,5mm 6,1mtr
	<b>TEXLEDDS-EL</b> 160x48mm 6,1mtr		

## PROFILES & ACCESSORIES / PROFILÉS & ACCESSOIRES

### H-SUPPORT PROFILE / PROFILÉ DE RENFORT-H

product code	profile / profilé
	<b>TEX-H</b> 36x19mm 3mtr
	<b>TEXCLAMP</b> for profile / pour profilé TEX-H
	<b>TEXCORNH</b> connector for profile / connecteur pour profilé TEXLEDDS (BL/EL) + TEX-H TEXLEDDS (BL/EL) + TEX-H

### MOUNTING BRACKET SUPPORT DE MONTAGE EN DRAPEAU

product code	description
	<b>TEXBRACKET1</b> Wall mounting bracket for TEXLEDDS(BL/EL), TEXSSH27
	<b>TEXBRACKET2</b> Wall mounting bracket for TEXLED80, TEXLED80T TEXLED100, TEXLED100T

## PROFILES & ACCESSORIES / PROFILÉS & ACCESSOIRES

### CORNER CONNECTORS CONNECTEURS D'ANGLE

product code	description
	<b>TEXCORNS</b> for profile / pour profilé TEXSSH27 (4 pcs), TEXNICHE (4 pcs) TEXDSDL45 (4 pcs)
	<b>TEXCORNL</b> for profile / pour profilé TEXSSLD15 (4 pcs), TEXSSLD19 (4 pcs) TEXSSH27 (4 pcs), TEXDSD44 (8 pcs) TEXLLS32 (4 pcs), TEXLEDDS40 (4 pcs)
	<b>TEXLEDCORN1</b> for profile / pour profilé TEXLEDDS(BL/EL) (8 pcs) TEXLEDDS(BL/EL) (8 pcs)
	<b>TEXLEDCORN2</b> for profile / pour profilé TEXLED80 (8 pcs), TEXLED80T (8 pcs) TEXLED100 (8 pcs), TEXLED100T (8 pcs) TEXLEDDS60 (4 pcs), TEXLEDDS80 (8 pcs) TEXLEDDS100 (8 pcs)
	<b>CONNECTOR1</b> for profile / pour profilé TEXLEDDS40 (1 pc)
	<b>CONNECTOR2</b> for profile / pour profilé TEXSSH27 (1 pc), TEXDSD44 (2 pcs) TEXNICHE (1 pc), TEXLED80/ 80T (2 pcs) TEXLED100/ 100T (2 pcs) TEXLEDDS60 (2 pcs) TEXLEDDS80 (2 pcs), TEXLEDDS100 (2 pcs)
	<b>CONNECTOR3</b> for profile / pour profilé TEXLEDDS (BL/EL) (2 pcs) TEXLEDDS (BL/EL) (2 pcs)

\* Note: The numbers mentioned between brackets indicate the number of corners per frame or connectors per connection.

### FLOOR PLATES PIEDS

product code	description
	<b>TEXCIRCLE</b> circle / circle ø 450 x 6mm
	<b>TEXHOOP</b> hoop / cerceau ø 450 x 6mm

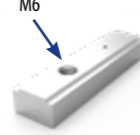
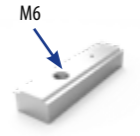

### SUSPENSION CLIP CLIP SUSPENSION

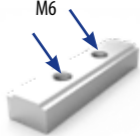
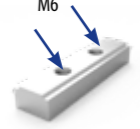

product code	description
	<b>TEXHANG1</b> metal suspension clip for 1.5mm cable/ clip suspension metal pour cable TEXDSD44, TEXLEDDS-EL
	<b>TEXHANG2</b> metal suspension clip for M6 rod/ threaded bar/ clip suspension metal TEXLED80T / TEXLED100T

### MOUNTING CLIP CLIP DE MONTAGE

product code	description
	<b>TEXMOUNT1</b> metal clip for M6 rod/ threaded bar/ clip metal TEXDSD44 / TEXLEDDS-EL
	<b>TEXMOUNT2</b> metal clip for M6 rod/ threaded bar/ clip metal TEXLED80T / TEXLED100T

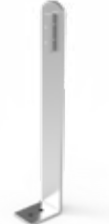
### STANDING KIT / KIT DEBOUT

product code	description
	<b>TEXFOOT40</b> foot / pied 400mm
	<b>TEXFOOT60</b> foot / pied 600mm
	<b>TEXFEETSIDE</b> side support / support latéral

product code	description
	<b>TEXBASE</b> baseball / base-ball 450 x 300 x 6mm
	<b>TEXFILLET</b> fillet / balafre 500 x 180 x 6mm

# FIXINGS



[www.cosign.be/fixings](http://www.cosign.be/fixings)

## TIMELESS ELEGANCE

Over the last 10 years, Cosign has become the leading manufacturer of standoffs & sign fixings in the Benelux. Our designers chose to create fixings in an austere and modern design, in high-quality stainless steel (AISI 303 and 304).

Even though the sign fixings were designed for indoor use, many customers also use them outdoors in non-aggressive environments. Environments with chlorine, salt and metallic fumes must be avoided.

The design takes into account compatibility with sheets of glass. We use silicon rings to protect the sheets of glass or set screws with a nylon tip wherever possible.

Starting in 2015, all our standoffs & sign fixings spacers will also be available in stylish silver anodised aluminium and in a blister pack that will include the wall screws, plugs and allen keys.

## ELEGANCE INTEMPORELLE

Au cours de ces 10 dernières années Cosign est devenu le principal fabricant d'entretoises dans le Benelux. Nos designers ont dès le début opté pour des entretoises d'un design sobre et moderne et pour une finition en acier inoxydable de qualité élevée (AISI 303 et 304).

Bien que les entretoises aient été conçues pour l'intérieur, elles sont aussi utilisées par de nombreux clients pour l'extérieur dans des environnements non agressifs. Bien sûr il convient toujours d'éviter les environnements avec du chlore, des sels et des vapeurs métalliques.

Lors de la conception il a été tenu compte avec la compatibilité avec des panneaux de verre. Ainsi il est fait usage au maximum de bagues de silicone afin de protéger le panneau de verre ou on utilise des vis de serrage avec une pointe en nylon.

A partir de 2015 nos entretoises seront aussi proposées avec une finition aluminium anodisée argentée très stylée dans un emballage sous blister pratique contenant également les vis murales, les chevilles et les clés de réglage.

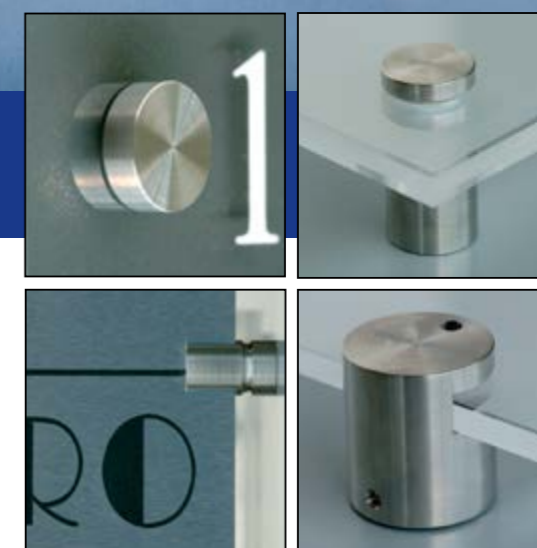

## DISTANCE HOLDERS / FIXATIONS DE TABLEAUX

### MOUNT BUTTONS / DÉCOCAPS

code inox code inox	code aluminium code aluminium	diameter (A) diamètre
MB130000	MB130000-A	13mm
MB180000	MB180000-A	18mm

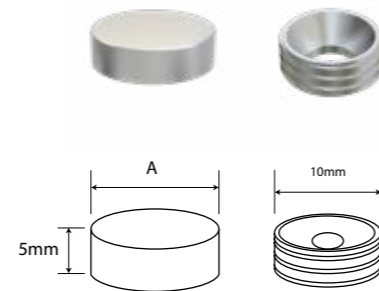

### DISTANCE HOLDERS / FIXATIONS MURALES PERCÉES

code inox code inox	code aluminium code aluminium	diameter (A) diamètre	projection (B) projection	panel thickness épaisseur	diameter drillhole trou de forage
DH131507	DH131507-A	13mm	15mm	2-7mm	8mm
DH132012	DH132012-A	13mm	20mm	2-12mm	8mm
DH181507	DH181507-A	18mm	15mm	2-7mm	12mm
DH182512	DH182512-A	18mm	25mm	2-12mm	12mm
DH302512	DH302512-A	30mm	25mm	2-12mm	15mm

## DISTANCE HOLDERS / FIXATIONS DE TABLEAUX

### THIN HEAD DISTANCE HOLDERS / FIXATIONS MURALES PERCÉES

code inox code inox	code aluminium code aluminium	code black code noir	diameter (A) diamètre	projection (B) projection	panel thickness épaisseur	diameter drillhole trou de forage
DH131507-T	DH131507-TA	DH131507-TB	13mm	15mm	2-7mm	8mm
DH132012-T	DH132012-TA	DH132012-TB	13mm	20mm	2-12mm	8mm
DH181507-T	DH181507-TA	DH181507-TB	18mm	15mm	2-7mm	12mm
DH182512-T	DH182512-TA	DH182512-TB	18mm	25mm	2-12mm	12mm

### SIDE GRIP PANEL SUPPORTS / FIXATIONS MURALES FENDUES

code inox code inox	code aluminium code aluminium	diameter (A) diamètre	projection (B) projection	panel thickness épaisseur
SG182008	SG182008-A	18mm	20mm	max 8mm
SG302008	SG302008-A	30mm	20mm	max 8mm

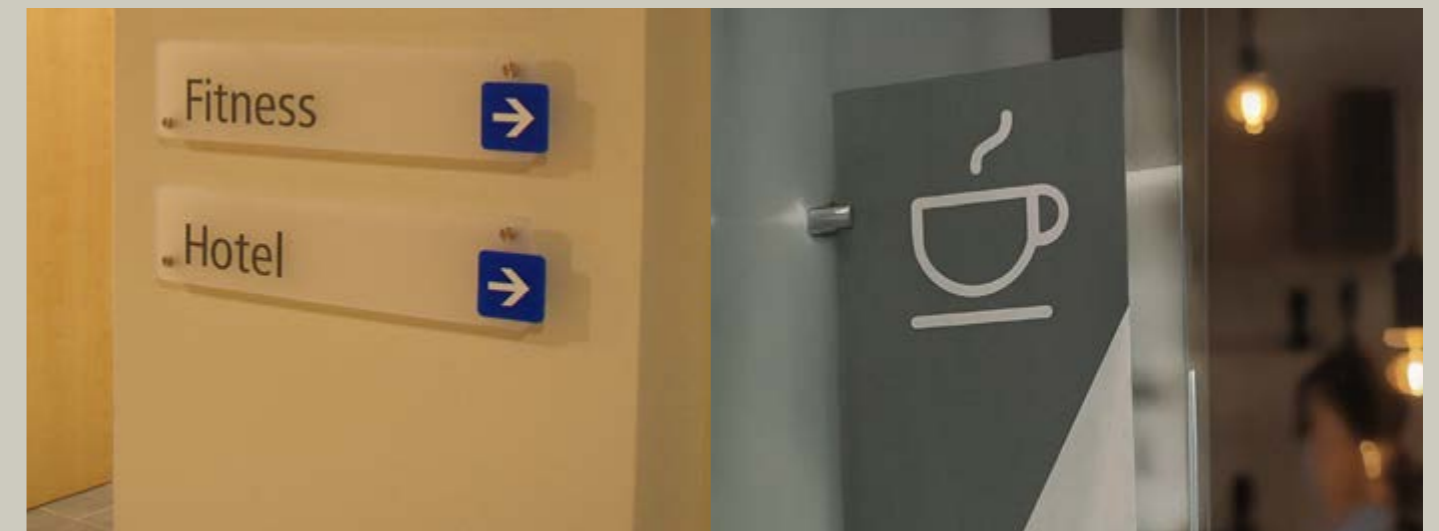

## DISTANCE HOLDERS / FIXATIONS DE TABLEAUX

### WALL-CEILING PANEL GRIPS / SUPPORTS MUR-PLAFOND

code inox code inox	code aluminium code aluminium	code black code noir	diameter diamètre	panel thickness épaisseur
WG170008	WG170008-A		17mm	max 8mm
WG120003	WG120003-A	WG120003-B	12mm	max 3mm

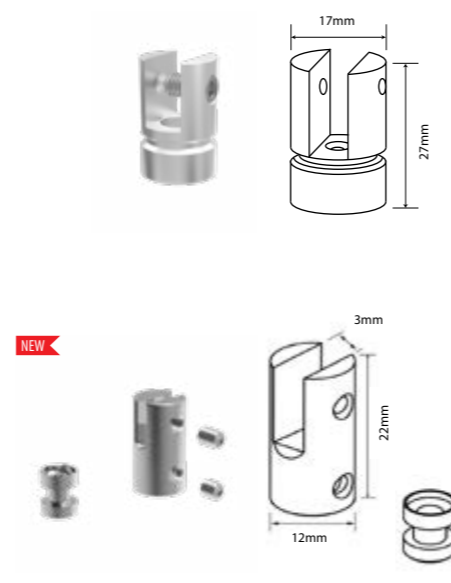

### SUSPENSION KIT / KIT SUSPENDU

code inox code inox	code aluminium code aluminium	diameter diamètre	panel thickness épaisseur	description description
CC15HP06	CC15HP06-A	17mm	max 6mm	suspension clamp support pour panneau suspendu
CC15KIT4	CC15KIT4-A	17mm	max 6mm	suspension kit incl. ceiling connector and wire. kit suspendu, fixation plafond et câble inclus.

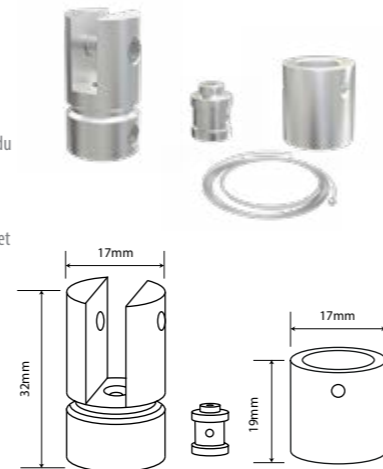

## DISTANCE HOLDERS / FIXATIONS DE TABLEAUX

### SUSPENSION KIT MINI / KIT SUSPENDU MINI

code inox code inox	code aluminium code aluminium	code black code noir	diameter diamètre	panel thickness épaisseur
CC15HP03	CC15HP03-A	CC15HP03-B	17mm	max 3mm
CC15KIT4-MINI	CC15KIT4-MINI-A	CC15KIT4-MINI-B	12mm	max 3mm



### SIGN CLAMPS / SUPPORT D'ENSEIGNES

code aluminium code aluminium	length longueur	panel thickness épaisseur
SC080W08-A	80mm	1-8mm
SC120W08-A	120mm	1-8mm
SC180W08-A	180mm	1-8mm
SC080P08-A	80mm	1-8mm
SC120P08-A	120mm	1-8mm
SC180P08-A	180mm	1-8mm

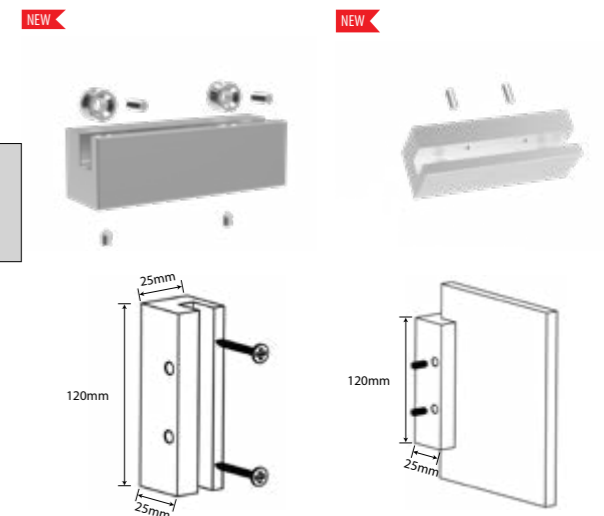

# SUSPENSION KITS



[www.cosign.be/suspension](http://www.cosign.be/suspension)

## EASE OF USE

Cosign developed a range of suspension systems which guarantee an easy, cost effective and safe suspension of signage, lighting systems, cable trays and other applications.

All systems have a built-in locking mechanism that grips cables automatically. To release, just press the clutch button, and the cable is free to move back and forth to achieve the desired length.

Our suspension range offers a solution for all types of ceilings: conventional ceilings, suspended ceilings, ceilings with metal tiles or high open ceilings with visible structural supports.

## FACILITÉ D'UTILISATION

Cosign a développé une série de systèmes de suspension qui garantissent un montage simple, bon marché et sécurisé des panneaux signalétiques, systèmes d'éclairage, supports de câbles et autres applications.

Tous les systèmes sont équipés d'un dispositif de verrouillage intégré qui serre automatiquement les câbles. Pour les libérer, il suffit d'appuyer sur le bouton de verrouillage, ce qui permet de déplacer les câbles d'avant en arrière pour obtenir la longueur souhaitée.

Notre gamme de systèmes de suspension offre une solution pour tous les types de plafonds : plafond conventionnel, plafond suspendu, plafond couvert de cassettes métalliques ou encore haut plafond ouvert avec supports structurels visibles.



## SUSPENSION CLIPS / CLIPS DE SUSPENSION

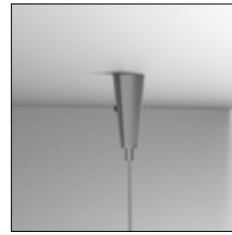

code	description	cable thickness	max weight
APC-4001	Suspension Clip Conical	max 1.5mm	20,0kg
APC-4001-B	Suspension Clip Conical - Black	max 1.5mm	20,0kg

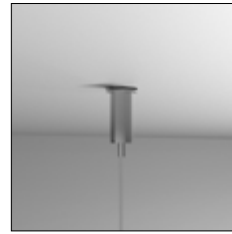

code	description	cable thickness	max weight
APC-4002	Suspension Clip Cylindrical	max 1.5mm	20,0kg
APC-4002-B	Suspension Clip Cylindrical - Black	max 1.5mm	20,0kg

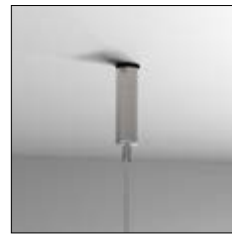

code	description	cable thickness	max weight
APC-4003	Suspension Clip Eco	max 1.5mm	20,0kg
APC-4003-B	Suspension Clip Eco - Black	max 1.5mm	20,0kg

## CABLE



code	description	cable thickness	max weight
APC-CABLE-1.5	Galvanized cable (7x7) 1,5m length with 4,5mm ball nipple	1.5mm	16kg
APC-CABLE-1.5-B	Galvanized cable (7x7) 1,5m length with 4,5mm ball nipple - Black	1.5mm	16kg

### NOTE:

Always consider maximum load of any used part of the total suspension system.  
Il est important de toujours tenir compte du poids maximum de chaque utilisée du système de suspension totale.

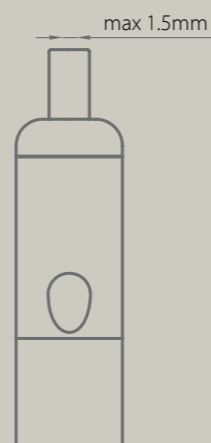
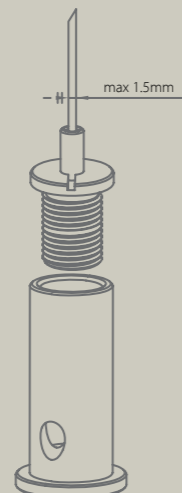

## MAGNETIC ANCHOR / ANCRE MAGNÉTIQUE



code	description	cable thickness	max weight
APC-MG32	Magnetic Anchor 32mm incl gripper	max 1.5mm	2kg
APC-MG32	Magnetic Anchor 32mm incl gripper	max 1.5mm	2kg



## DOUBLE GRIPPER

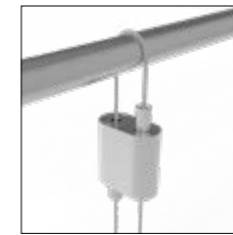

code	description	cable thickness	max weight
APC-DG15-B	Double Gripper 1.5mm Black	max 1.5mm	20kg
APC-DG15-S	Double Gripper 1.5mm Silver	max 1.5mm	20kg
APC-DG30-B	Double Gripper 3.0mm Black	max 3.0mm	90kg
APC-DG30-S	Double Gripper 3.0mm Silver	max 3.0mm	90kg



## TWISTER CLIPS



code	description	cable thickness
APC-TW00	Twister Clip with 5,6mm loop	-
APC-TW03	Twister Clip with Gripper	max 1.5mm



magnet strength: N35

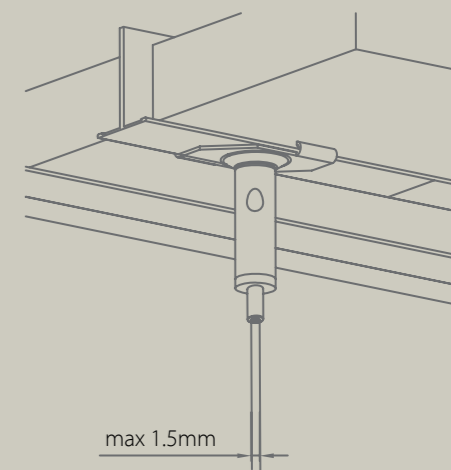
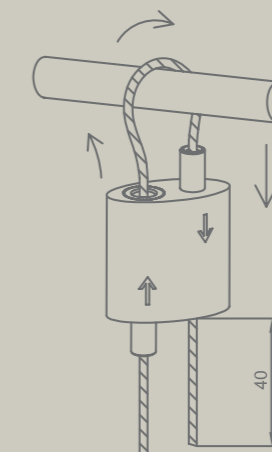

# COSIGN

INDOOR SIGNAGE



**INDOOR SIGNAGE | OUTDOOR SIGNAGE | FRAMES & DISPLAYS | LED SOLUTIONS**

Cosign is a designer, manufacturer and distributor of architectural signage & way finding, poster frames & displays and LED signage solutions. Based in Belgium with regional offices in Mexico, Brazil and India, and through our global partner network, our sign solutions are available in more than 85 countries.

Cosign est un concepteur, fabricant et distributeur de solutions de signalétique & orientation architecturale, de cadres & supports de posters et solutions de signalisation LED. Nous sommes basés en Belgique et possédons des antennes régionales au Mexique, Brésil et en Inde. Grâce à notre réseau mondial de partenaires, nos solutions d'affichage sont disponibles dans plus de 85 pays.

**COSIGN**  
MODULAR SIGN SYSTEMS

COSIGN nv  
Industriepark 32 B  
B-3290 Diest  
Belgium  
[www.cosign.be](http://www.cosign.be)



YOUR DEALER / VOTRE REVENDEUR: